

MARCH 1980

HEWLETT-PACKARD JOURNAL



Contents:

- 3 Powerful Personal Calculator System Sets New Standards**, by Bernard E. Musch, John J. Wong, and David R. Conklin *It's not only a powerful handheld calculator, but also the nucleus of a computer system that fits in a briefcase.*
- 7 Packaging the HP-41C**, by Gerald W. Steiger *The liquid crystal display made it interesting for the package designers.*
- 12 Card Reader Offers Compatibility and Expanded Capability**, by David J. Lowe and Patrick V. Boyd *More powerful and useful than its predecessors, the HP-41C card reader can read cards written by earlier HP personal calculators.*
- 15 Evolutionary Printer Provides Significantly Better Performance**, by Roger D. Quick and Donald L. Morris *As the power of a calculator increases, so must the abilities of its printer.*
- 20 Bulk CMOS Technology for the HP-41C**, by Norman L. Johnson and Vijay V. Marathe *This integrated circuit process has many characteristics that contribute to long battery life in a calculator.*
- 22 The First HP Liquid Crystal Display**, by Craig Maze *LCD advantages include low voltage and power requirements and good visibility in strong light.*
- 25 High Density and Low Cost with Printed Circuit Hybrid Technology**, by James H. Fleming and Robert N. Low *Silicon integrated circuit chips are mounted directly onto printed circuit boards to save space and cost.*
- 27 An Economical, Portable Microwave Spectrum Analyzer**, by David H. Molinari and Richard L. Belding *Lab-grade performance at a low price makes the advantages of microwave spectrum analysis available to more engineers.*

In this Issue:



Well, they've done it again. Just when I think I know the difference between a calculator and a computer, along comes a product that doesn't quite fit either category. In this case it's our March cover subject, the HP-41C. It's called a calculator and it looks like a calculator. It fits in your hand and has a keyboard and a liquid crystal display. But it accepts peripheral devices like a computer. There's a printer, a magnetic mass storage device, add-on memory modules, and an optical wand. And look at its command structure. Some of its functions are accessed by single keystrokes, like a calculator's, but other functions are accessed by spelling out their names on the alphanumeric keyboard, and this is very computer-like. So what is the HP-41C, calculator or computer? We'll call it a calculator, but it's really a little of both.

If you look into the ports on top of the HP-41C where the peripherals plug in, what you see is the calculator's system bus. When you have a small, powerful, inexpensive processor with its system bus exposed, it's natural for people to think of connecting things to that bus and using the processor to control various kinds of specialized systems. *Prediction:* someday you'll be able to buy HP-41C systems and peripherals that don't come from Hewlett-Packard.

Also featured in this issue is a new spectrum analyzer, Model 8559A (page 27). A spectrum analyzer is a basic tool for microwave engineers. What it does is similar to what happens when you tune your radio from one end of the broadcast band to the other—every time you pass a station, you get some sound out of the speaker. A spectrum analyzer tunes rapidly across a very wide band—10 MHz to 21 GHz for the 8559A—and gives you a spike on a CRT display (instead of sound) whenever it encounters some energy. Model 8559A addresses a need that some of our customers have expressed. It's a high-performance instrument that uses state-of-the-art technology, but its price has been held down by not including features that aren't needed for most applications. This makes it affordable for many more microwave engineers.

-R. P. Dolan

Editor, Richard P. Dolan • Contributing Editor, Howard L. Roberts • Art Director, Photographer, Arvid A. Danielson
Illustrator, Nancy S. Vanderbloom • Administrative Services, Typography, Anne S. LoPresti • European Production Manager, Dick Leeksma

Powerful Personal Calculator System Sets New Standards

Customize this advanced new handheld calculator by plugging in extra memory, a magnetic card reader, a printer, and application modules. You can reconfigure the keyboard, too.

by Bernard E. Musch, John J. Wong, and David R. Conklin

THE MOST POWERFUL personal handheld calculator that Hewlett-Packard has ever designed, the new HP-41C, has over 130 preprogrammed functions and many advanced features, including a continuous memory that retains its information when the calculator is turned off, an alphanumeric liquid crystal display with status annunciators, a full alphanumeric keyboard that can be customized to fit user needs, and sophisticated but simple programming, including advanced editing, local and global labeling, specific loop control, flexible indirect addressing, and expanded decision-making capabilities.

In addition to these standard features, the HP-41C can become a powerful calculating system by means of options that can be connected to the basic machine through four ports on the top.

- Up to four memory modules can be added, increasing available program memory or data storage by 400 percent, up to 2000 lines of program memory or 319 data

storage registers, or any combination.

- A card reader allows the user to record and read programs on magnetic cards. Among its features are prompting and HP-67/97 compatibility.
- A portable thermal printer provides permanent records of calculations. It is also capable of high-resolution plotting.
- An optical wand (available later this year) will read and enter programs and data from printed bar codes.
- Plug-in application modules offer preprogrammed solutions to problems in specific areas.

The HP-65, introduced in 1974, and the HP-67, introduced in 1976, were distinguished by electronic and mechanical features that represented an evolutionary follow-on to the HP-35, HP's first handheld calculator. They had numeric LED (light-emitting diode) displays and P-channel MOS (metal-oxide-semiconductor) circuitry. The HP-41C represents both an evolution of capabilities



Fig. 1. The new HP-41C Calculator can be expanded like a computer system to include add-on semiconductor memory, mass memory, and hard-copy output. Here the HP-41C is shown with add-on memory modules and its optional magnetic card reader and thermal printer.

and system architecture and a significant departure in technology and configuration. The HP-41C uses CMOS (complementary MOS) circuits throughout and has an alphanumeric liquid crystal display. The configuration of the HP-41C is very much like a computer system. The handheld calculator is part of a distributed system that can include add-on semiconductor memory devices, a mass memory device, and a hard-copy output device. Fig. 1 is a picture of a system that includes the HP-41C Calculator, the 82106A Memory Module, the 82104A Card Reader, and the 82143A Printer.

USER Mode

One of the most unusual features of the HP-41C was developed in response to the distributed nature of the system. It is the concept of USER mode and the capability for the user to completely reconfigure the calculator's keyboard.

USER mode can be best understood by considering the dilemma of where to put a key labeled PRINT on a machine that may or may not have a peripheral printer attached. For the user with the printer, the PRINT label should be in a prominent place, most likely on a keytop. For a user without a printer, putting a PRINT label on a keytop is a waste of a valuable commodity, a primary key.

A related dilemma is the proliferation of functions in this kind of system compared to the limited and relatively constant number of keys and surfaces on which to inscribe the nomenclature for these functions. The traditional solution has been to provide multiple shift keys and nomenclature in several colors to access various functions with each key. With USER mode, the solution is to provide only frequently used functions on the keytops and keydeck, and a single shift key. The front slopes of the keys are reserved for the alphabet and characters for alpha mode, and a procedure is provided to assign any function—mainframe, plug-in, or user-generated—to any key, primary or shifted (see page 5). The user-assigned keyboard configuration is maintained while the calculator is off, so that it need not be reentered each time the calculator is turned on.

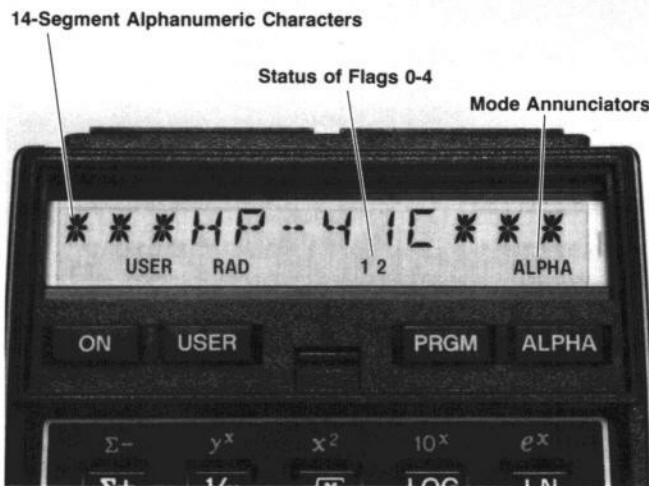

Fig. 2. The HP-41C's liquid crystal display features a full alphanumeric character set.

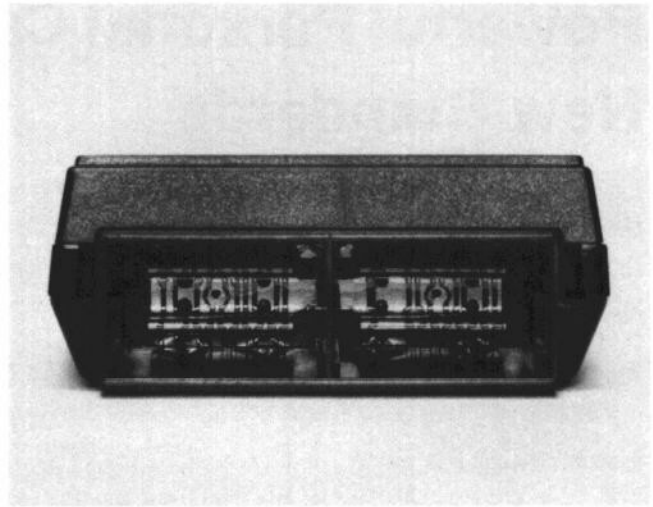

Fig. 3. Optional HP-41C peripherals plug into the mainframe via four I/O ports on top of the calculator.

Alphanumeric Display

A second major feature of the HP-41C is the alphanumeric display. Fig. 2 is a picture of the display showing its salient features. The uses of the alpha capability include input prompting (e.g., KEY IN COST) as well as output labeling with variable names and units (e.g., $X = 23.75 \text{ KM}$).

Prompting also extends to the key functions. Pressing any function key down and holding it will display the name of the function in the display for approximately one-half second. When the key is released, the function is executed. If the key is held down beyond the one-half second time period, the key nulls (i.e., is not executed). If the calculator is in the USER mode and the key has been reassigned, the function that is displayed and subsequently executed is the user's assigned function, not the one preprogrammed into the machine.

Additional uses of the alpha capability include displaying the program steps in program mode with the actual function name, and the generation of explanatory error messages, such as NONEXISTENT in response to an attempt to address a nonexistent register and DATA ERROR in response to an attempt to perform a mathematically impossible operation such as division by zero.

Providing a useful alphanumeric capability consistent with a conceptual extension of the HP-65/67/97 operating system was an interesting challenge. The solution consisted of providing an alpha register separate from the user's addressable memory and the operational stack. This register is capable of holding up to 24 alpha characters. Pressing the ALPHA key on the keyboard causes two things to happen: the contents of the alpha register are displayed, and the keyboard is converted into an alpha entry keyboard using the character set printed in blue on the front slope of the keys. Various functions in the machine's function set enable the user to manipulate and view the contents of the alpha register both from the keyboard and/or under program control.

Input/Output Ports

The third area of distinction for the HP-41C is the capabil-

ity of expanding the system's hardware using the four I/O ports on the top of the calculator (Fig. 3). The calculator's system bus is accessible at the I/O interface. This enables the user to expand the system by plugging in any device capable of interfacing to this bus. For example, add-on ROM (read-only memory) can increase the function set of the machine with programs written either in the machine's operating language or as sequences of user instructions. Plug-in RAM (random-access read/write memory) can expand the user's storage space for data and programs. Peripheral devices can be added to the system, with each device's function set contained in the ROM associated with the device itself. Thus, the user only pays for the capability to drive any peripheral when the peripheral is actually purchased. As of this writing, available peripherals include a magnetic card reader and a thermal printer, with an optical bar code reader due to be available in early 1980. Detailed descriptions of the first two devices are included in other articles in this issue.

System Architecture

A close look at the HP-41C architecture reveals an evolutionary design with close ties to the HP-35¹ and HP-21² families. In fact, the system timing is compatible with the HP-21 and much of the instruction set is very similar. The decision to stay with this familiar architecture allowed faster development and use of an existing circuit pioneered in the HP-25C.

Despite similarities in the architecture, there are many enhancements that make the HP-41C a much more powerful machine. Added features include a 2x improvement in operating speed, address expansion to 64K 10-bit words of ROM and 7K bytes of RAM, extensive I/O support with new peripheral instructions, a new display structure, and special power on-off controls. The chip set of the HP-41C includes one CPU (central processing unit), five data storage chips, three ROMs, and two display drivers, all CMOS, and one bipolar circuit. Fig. 4 is a block diagram of the system. With the exception of the display drivers, all the electronics are mounted on a single four-layer printed circuit board.

The calculator hardware can exist in any of three power

Using USER Mode

The procedure for the user to redefine a key on the HP-41C keyboard is simple and straightforward. If a peripheral device or application module is plugged into one of the I/O ports of the HP-41C, the user can execute the CAT 2 (Catalog 2) function to review the plug-in's repertoire of available functions. The listing below shows the function set of the printer.

CAT 2

```
-PRINTER-
ACA
ACCHR
ACCOL
ACSPEC
ACX
BLDSPEC
LIST
PRA
*PRAXIS
PRBUF
PRFLAGS
PRKEYS
PRP
*PRPLOT
*PRPLOT*
PRREG
PRREGX
PRE
PRSTK
PRX
REGPLOT
SKPCHR
SKPCOL
STKPLOT
```

To assign, for example, the PRX (Print X) function to the R/S key location:

User Keys In	Display Shows
ASN	ASN ____
ALPHA	ASN ____ ALPHA
PRX	ASN PRX ____ ALPHA
ALPHA	ASN PRX ____
R/S	ASN PRX 84

The underscore prompts for additional information, the alpha annunciator comes on to indicate that the keyboard is in alpha mode, and the 84 indicates that the key being assigned is the 4th key in the 8th row.

Now that the key has been reassigned, the user may invoke the PRX function merely by pressing the USER key (displaying the annunciator USER) and then pressing R/S. The USER key may be thought of as a permanent shift key that shifts every key from the normal definition to the user's own key definition.

If the R/S key is pressed and held in the USER mode, the mnemonic PRX is displayed as a reminder of what function is to be executed; to void or NULL out its execution the user merely holds the key down for more than 1/2 second. In this way the current redefinition of the keyboard may be reviewed without disturbing the contents of the machine's registers.

If the printer is now unplugged from the calculator and the R/S key is pressed and held the message XROM 29.20 appears in the display indicating that a function that is in a ROM external to the machine has been assigned to that key. The numbers indicate that it is the 20th function of device number 29 (the printer). Of course, both the name and the nature of XROM function 29.20 is unknown to the calculator as long as the printer module remains unplugged. Any attempt to execute an XROM function will result in NONEXISTENT in the display. The printer may be plugged in again (into any port) and the PRX function will reappear, assigned to the R/S key.

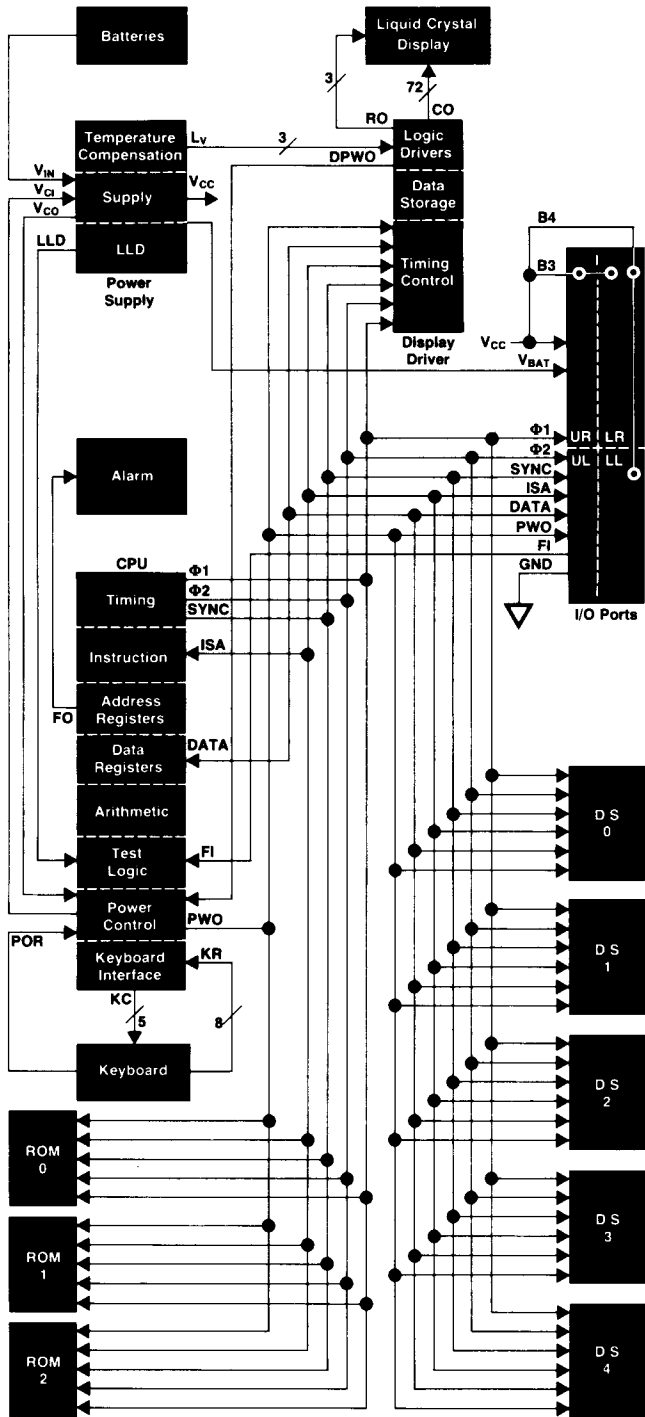

Fig. 4. HP-41C block diagram.

modes. The first mode is the SLEEP mode. All of the circuits are inactive, but are biased on by the battery to sustain the continuous memory, consuming only a few microamperes of current for the entire calculator. When the unit is turned on, it enters the RUN mode. The clocks are running, instructions are executed, data is transferred, and the display is initialized and enabled. Under software control, the calculator transfers to a STANDBY mode in which the clocks and CPU are stopped. Only the display and the power supply remain active, and timing is controlled by the inter-

nal oscillator in the display driver. The RUN mode is activated whenever a key is pressed, and the calculator returns to STANDBY mode between keystrokes. If there is no input activity for approximately ten minutes, the display driver times out and shuts off the system altogether and the calculator is again in SLEEP mode.

CPU

The CPU is one of eleven CMOS circuits inside the HP-41C that were all developed and are fabricated within Hewlett-Packard. In the design process, various computer-aided design tools were used for logic and circuit simulations, digitizing, and design rule checks to provide faster development and assure more accurate and reliable circuits.

Inside the CPU, there are five working registers (A, B, C, M, and N), one 8-bit register, one 14-bit status register, two pointers, and four subroutine return registers. The CPU supports 16 bits of ROM address, 10 bits of data register address, 56 keys with two-key rollover capability, 14 flag inputs and eight flag outputs. In the HP-41C, the flag output line is dedicated to driving the audible beeper.

In addition to these addressing and register capabilities, other CPU enhancements include new peripheral instructions to meet I/O demand, software-programmed on-off logic, automatic reset circuitry, and a new instruction to read ROM contents as data. The new instruction, CXISA, is especially useful for reading lookup tables, application ROMs, and ROM checksums.

Data Storage

There are five data storage circuits, each containing 16 56-bit registers of RAM (random-access memory). One of these circuits is allocated for internal storage, including the stack, display register, program pointers, and so on. The other four chips provide the user with 64 registers that can be partitioned between data and program memory at a rate of seven bytes of program per register.

In addition to the internal data storage, the HP-41C allows 16 more data storage circuits to be plugged into the system, four in each port. The I/O ports each have two pins that provide port address information to the plug-in memory modules. The memory modules are all identical and any number of them (up to four) can be in the system at any time. The only restriction is that the memory modules have to occupy ports starting with the lowest port number to provide a continuous program storage space.

The Display System

The display system consists of a 12-character, 14-segment liquid crystal display and a display driver hybrid that holds two display driver circuits. These are sandwiched together with connectors and clips. There are 75 connections between the LCD and the hybrid and 15 connections to the logic board.

The display is multiplexed three ways by scanning the three row lines on the backplane of the LCD and presenting the column information in parallel to all characters. An LCD segment is considered on when the rms voltage difference between that row and that column exceeds a certain threshold, and off if this voltage difference is below a cer-

Packaging the HP-41C

by Gerald W. Steiger

The design of the HP-41C borrows heavily from previous HP calculator designs. The contours of the case recall the classic HP-35. The mechanical design is similar to the HP-21, using four major subassemblies: display, top case/keyboard, logic board, and bottom case.

The display assembly, Fig. 1, required the most new mechanical design work, primarily because of space restrictions, but also because the HP-41C is HP's first liquid crystal display product. Because the alphanumeric LCD requires so many connections, a display driver hybrid is connected directly to the LCD through elastomeric connectors on the long sides of the display. Registration of the hybrid to the LCD is established by a plastic locator bonded to the LCD. The assembly is held together by two spring clips that provide the required contact pressure and protect the glass LCD from impact. The display assembly is attached to the keyboard by a comb of contacts that are reflow soldered to the hybrid and keyboard (Fig. 1).

The keyboard is heat-staked to the top case as in the HP-21 and uses metal discs for key contact and tactile feedback as in the HP-19C. Removable overlays and transfer labels keep track of redefined keys. Using a momentary-contact ON/OFF circuit eliminates the need for slide switches and the special plating they require.

The logic board, Fig. 2, makes contact to the keyboard through another elastomeric connector, again because of space restrictions. Contact pressure is maintained by two nuts driven over the top-case screw bosses. A spacer, sonic welded to the bosses, establishes the logic board height and prevents overdriving of the nuts from affecting key feel. The piezoelectric beeper is mounted to the logic board to facilitate assembly and repair. Foam tape presses the beeper against the bottom case, which acts as a sounding board.

The bottom case contains the I/O ports and the one-piece battery case/door. The battery springs are used as jumpers, to apply contact

force, and to hold the case in place, as in the HP-21. There are two small cantilever springs to hold the cells in place while outside the calculator. The battery and I/O contacts are on a flexible printed circuit that is wrapped around and heat-staked to a plastic contact frame. The batteries make contact at the ends of four small ribs. The I/O contacts are made on the tops and bottoms of four larger ribs, like edge connectors on a hard printed circuit board. A piece of polyurethane foam held in the top of the contact frame presses the flexible circuit against the keyboard to make contact there. Four screws attach the bottom case to the top case, trapping the contact frame and the center case, a cosmetic piece, between them.

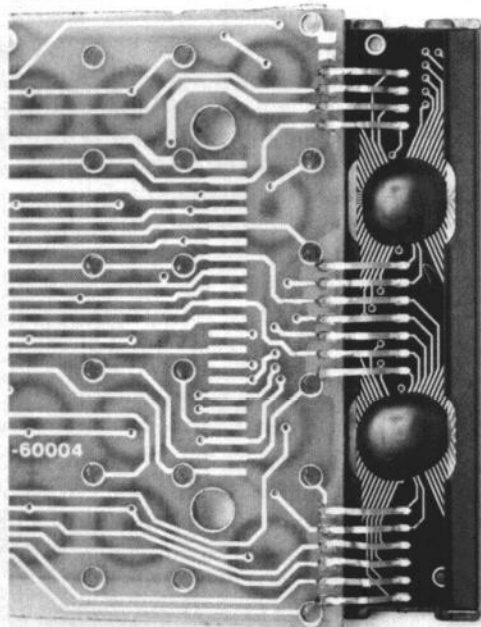

Fig. 1. HP-41C display assembly.

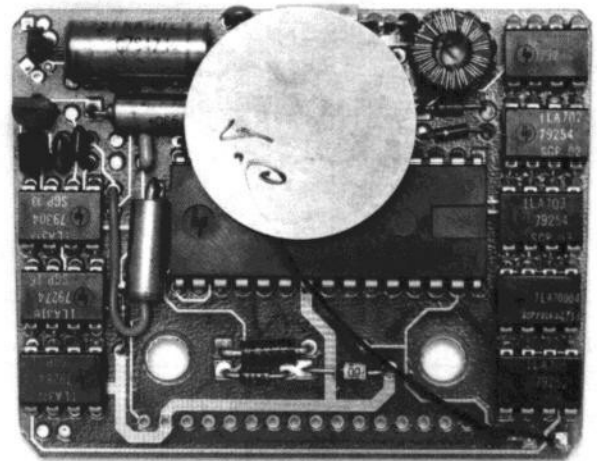

Fig. 2. HP-41C logic board.

Gerald W. Steiger



Jerry Steiger is a native of eastern Oregon and a graduate of the University of California at Berkeley, where he received his BSME degree in 1970 and his MSME degree in 1972. After three years doing product design for toys and label guns, he joined HP's Advanced Products Division (now the Corvallis Division) in 1975 to assist in the development of the HP-10 and HP-19C printers. For the HP-41C, he was the primary mechanical designer and worked on production engineering. Married and living in Corvallis, Jerry has a 2-year-old daughter and is interested in music, science fiction and fantasy, military history, wargaming, and downhill skiing.

tain off threshold. The drive waveforms use a four-level scheme that provides optimum on and off rms voltage differences of 2.1V and 1.1V, respectively. Fig. 5 shows the drive waveforms required to produce letters H and P. The rms values are computed by averaging the squares of the row-column differences over the six time periods shown. In letter P, for example, segment 14 sees an rms voltage difference between row 1 and column 4 of:

$$\left\{ \frac{1}{6} [(1.1-0)^2 + (3.3-2.2)^2 + (1.1-2.2)^2 + (2.2-3.3)^2 + (0-1.1)^2 + (2.2-1.1)^2] \right\}^{1/2} = 1.1V$$

Thus segment 14 is off.

There are two identical display driver circuits, each driving six characters of the display. The two chips act as stand-alone peripherals to the system, with all controls,

First digit is row number.
Second digit is column number.

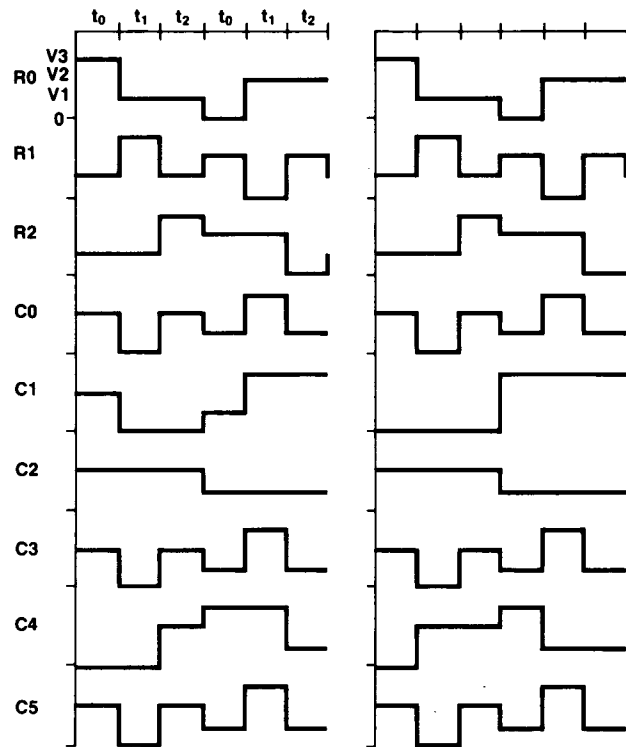
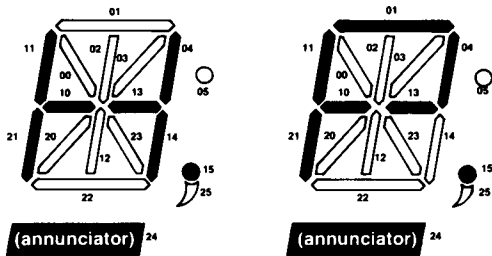

Fig. 5. Display drive waveforms to produce letters H and P. Voltages V1, V2, V3 are 1.1V, 2.2V, and 3.3V. An LCD segment is on if the rms difference between the row and column voltages applied to it is 2.1V. The segment is off if this rms difference is 1.1V.

registers, ROM, buffers and drivers built in. The two circuits are connected in a chain, with information passed back and forth between them. To the system they look like a single 12-digit driver. The chips may be cascaded beyond two to handle systems with larger displays.

Information for each character is stored as a 9-bit string. Seven bits are used for the character's ASCII* equivalent—only 80 characters are decoded and displayed—and two bits are for the punctuation field. There is a separate bit per digit for the annunciators. The data from the CPU can be sent in 9-bit, 8-bit, or 4-bit (for numerics) fields in single-character or multicharacter form, from left or right side. The display can also be shifted left or right one digit at a time. All the column data is updated each time new information is sent and the decoded outputs are buffered in a three-bit shift register for each column. This is necessary because the columns are scanned at a slow rate; it also allows the display to be system-independent during STANDBY mode.

Power Supply Circuit

The HP-41C is powered by four N-size alkaline batteries with supply voltages ranging between 6V and 4V. Although CMOS can operate down to the 4V level, the speed would be greatly reduced. To optimize performance and provide LCD drive voltages and several other analog functions, a custom bipolar circuit was designed to perform the power supply functions.

The design goals for the bipolar circuit were to provide extremely low power and highly efficient operation. This circuit follows the three modes of calculator operation. In SLEEP mode, the CPU disables an input control pin, which shuts off all bias current to the internal circuits. In this mode, the chip draws less than 1 μ A of current. In STANDBY, the chip is active, providing the 6V and LCD voltages, but at very minimal current. In RUN mode, the supply delivers as much power as needed by the system and its plug-ins up to 20 mA.

There are two internal references inside the power supply circuit, one for the 6V and one for the LCD voltages. The 6V supply is constant for a wide range of battery voltages and the full range of loading conditions. Outputs of 3.3V, 2.2V, and 1.1V are generated and held to very tight tolerances to provide good contrast and viewing angle for the display. These voltages also have a negative temperature coefficient of -20 mV/degree C to compensate for the LCD threshold change with temperature. There is a low-battery detection circuit that signals the CPU to activate the BAT annunciator when the battery is weak. The bipolar chip also generates a handshake signal that indicates to the CPU that the system voltage is adequate to start the rest of the circuits.

ROM

The HP-41C contains 12K words of system ROM (read-only memory), partitioned into three ROM chips with 4K words of 10 bits in length. That is 16 times more ROM than the HP-35 and more than twice that of the HP-67.

There are 16 bits of address field. The four upper bits are used as a chip-enable code to select one of 16 ROM circuits. The system ROM chips occupy the lower three addresses with peripherals filling in above them. The eight upper

*American Standard Code for Information Interchange

ROM locations are reserved for the plug-in application modules. With the two port address lines controlling bit 13 and bit 14 of the ROM address, the system can accommodate four plug-in application ROM modules at the same time, each containing one or two ROM circuits. An application ROM takes on the physical address of the port it is plugged into, but this is invisible to the user; the ROM operates in the same way in all four ports. Since different application ROMs can use the same physical address at different times, the number of possible application ROMs is not limited by the hardware.

Operating System and Firmware

The basic functions of the mainframe microcode may be seen in the flowchart in Fig. 6. The processor goes into its STANDBY stage between keystrokes to conserve power. Pushing a key causes the microprocessor to wake up and begin executing instructions. Some simple tests are run to ensure that the contents of RAM have not been lost, and then the keyboard is interrogated to see which key was pushed. It is possible for a peripheral to wake up the processor without a key being pushed. In this event the operating system jumps to a standard entry point in each plug-in ROM to give the ROM associated with the peripheral a chance to service the peripheral. There are seven standard entry points in each plug-in ROM to facilitate polling the plug-ins under various conditions.

In contrast to earlier HP handheld calculators, the mapping of a key onto the corresponding function can be an elaborate process in the HP-41C. When the calculator is in USER mode, a bit map of all the key locations is examined to see if the user has explicitly redefined the key. If not, a test is made to determine if the key is one of the auto-assignable keys. If the key is auto-assignable, a local label search must be conducted in the current user program to see if the corresponding label exists. Only after these possibilities have been checked does the operating system map the key onto its default function.

The HP-41C allows the user to access a function that is not assigned to any key by spelling out its name. The named function may be a mainframe function, a function in a plug-in application ROM or peripheral, or an alpha label in user program memory. The firmware searches through user program memory, all plug-ins, and the mainframe, in that order. There are no mechanisms to prevent a user from spelling a label the same way as a ROM function name, but the order of the search guarantees that the user's function will be found instead of the ROM function. Within user program memory, the search is conducted backwards, starting with the last label in program memory and working toward the beginning of program memory. This tends to result in the most recently entered label being found when there are duplicate labels in memory.

The CATALOG function was included to remind the user of all the functions available at any time. The order of the catalogs reflects the alpha name search order: CATALOG 1 displays alpha labels in program memory, CATALOG 2 displays plug-in functions, and CATALOG 3 shows the complete list of mainframe functions. Tables of pointers in the mainframe and at the beginning of each plug-in ROM determine the order of the entries in CATALOGS 2 and 3.

CATALOG 1 displays alpha labels in order from the top of program memory to the bottom, that is, oldest first, the reverse of the search order. CATALOG 1 also displays END statements in program memory, so that the user can tell which labels are in the same program. When CATALOG 1

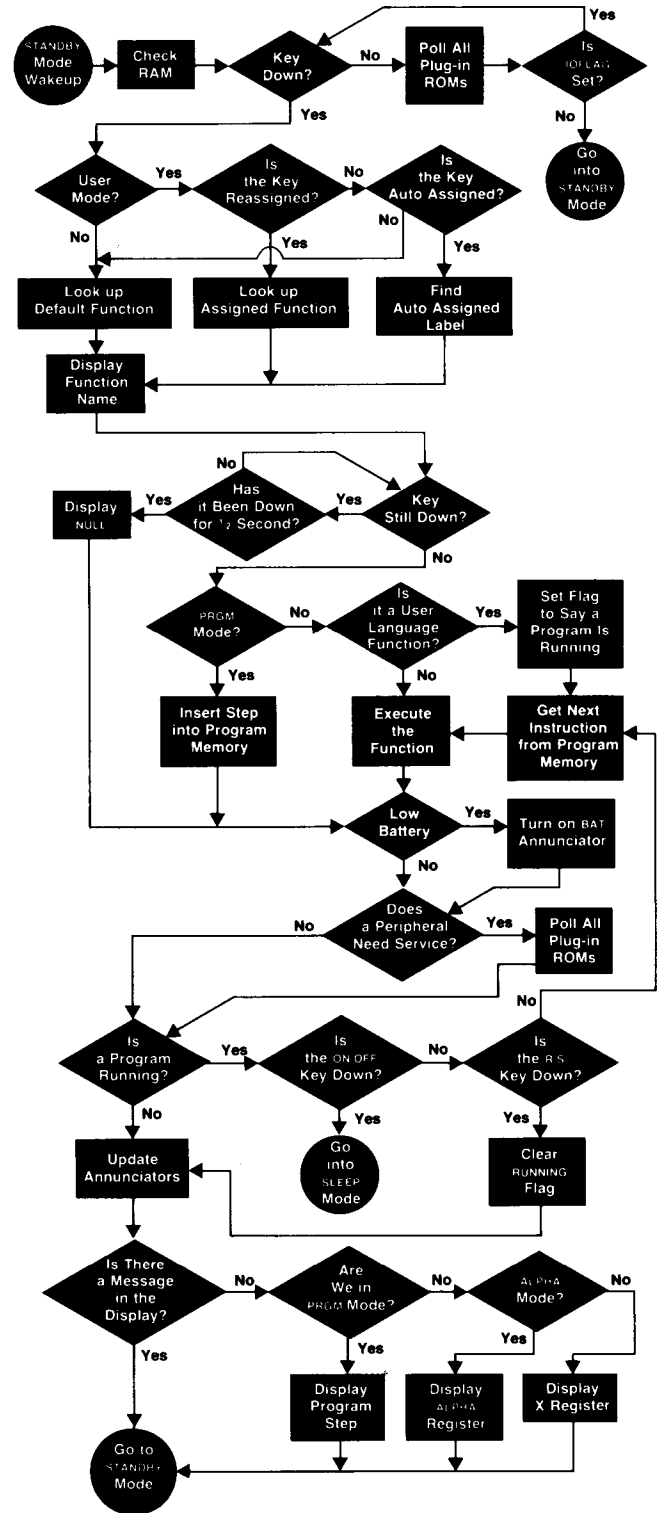

Fig. 6. Basic HP-41C microcode operation for single-key-stroke functions. The calculator goes into a STANDBY state between keystrokes to conserve power.

executes, the user program counter is moved to each label or END as it is displayed; this allows access to programs that contain no alpha labels.

Alpha labels and ENDS are linked together in a chain. Each label or END contains a pointer to the label or END preceding it in program memory. This chain is traversed in its natural order when a search for an alpha label is conducted. When CATALOG 1 is executed, the firmware runs up the label chain to its end, counting the number of links. The final entry in the chain, which is at the top of program memory, is displayed first. For successive entries in the catalog, the counter is decremented and the chain is traversed again up to the link corresponding to the counter.

User Program Memory Maintenance

Operations on user program memory were particularly challenging to implement on the HP-41C. The processor speed, although fast in comparison to previous HP battery-operated calculator processors, is still very slow in absolute terms. The speed problem was compounded by potential memory configurations up to 10 times larger for user programs than on the HP-67. This combination of factors rendered the traditional methods of editing user program memory and searching for labels in user program memory prohibitively slow.

On the HP-67 or HP-97, when a step is inserted into the user's program, the remaining steps are moved down one byte at a time. On deletion of a step, remaining steps are moved up to fill the gap. Memory maintenance on the HP-41C, however, is closer to disc file maintenance than to the method used in the HP-67. When a step is deleted from an HP-41C user program, a null code is inserted in its place and no steps are moved. When a step is inserted, an examination is first made to determine whether there are nulls at the desired location that can be overwritten. If not, then seven bytes are made available by moving the remaining program steps down by one full register. The register move operation is intrinsically faster than the byte-by-byte move made on the HP-67. If several steps are to be inserted at the same place, register moves will generally only be necessary on the first insertion. Succeeding steps are inserted into the extra space created by the first insertion. An occasional PACK operation is necessary to reclaim randomly distributed nulls. When the HP-41C runs out of room, it PACKS automatically. The user can also invoke the PACK function explicitly.

Local versus Global Labels

In the HP-67, each time a user label is referenced by a GTO or GSB instruction, a linear search is made through the entire user program memory to find the label. The time spent searching for labels often represents a significant fraction of the execution time for HP-67 programs. On the HP-41C, several techniques have been used to minimize label search time. The HP-41C has two classes of labels: global alpha labels and local numeric labels. The END function on the HP-41C is used to divide user program memory into independent program spaces. When a reference is made to a local label, the search for the label is conducted only in the current program space, thereby shortening the search time. Once the target label is found, its location is

stored with the GTO that referenced it; in other words, the GTO is "compiled." The search is eliminated altogether on subsequent executions of the GTO function if the program has not been edited in the meantime. Global alpha labels are used for references across program space boundaries. The alpha label chain described above serves to speed up the search for global alpha labels.

The concepts of global versus local labels and separate program spaces, although not new to computer programmers, are important advances for a programmable calculator. A user can always write a new program without worrying about what numeric labels have been used in programs already in the machine, simply by creating a new program space. Users can similarly exchange and use each others' subroutines without regard for conflicting numeric labels. Moreover, the global alpha labels used to name programs can be up to seven characters in length, long enough to be meaningful and memorable.

Support of Plug-ins

A number of techniques were used in the HP-41C firmware to allow for plug-in application ROMs and peripherals. First, all functions in plug-ins are accessed by a logical ROM ID and function number, rather than by a physical address. This allows plug-ins to work without regard to which of the four ports they are plugged into. When such a function is executed, the firmware searches through all of the ports until it finds the ROM bearing the ROM ID of the function. Second, provisions have been made to allow plug-ins to seize control of the CPU at certain times, such as just before the CPU goes into STANDBY mode. The firmware polls all of the plug-ins whenever any one of seven events happens. Third, some subroutines are included in the mainframe specifically to permit the use of address-independent microcode in the plug-ins, which may take on the physical address of whichever port they are plugged into. Fourth, a number of subroutine calls to the printer ROM (which has a fixed, rather than port-dependent, physical address) are embedded in the mainframe firmware to permit the intimate interaction between printer and keyboard that was pioneered by the HP-97. In this case the firmware takes advantage of a feature of the CPU that causes an immediate return to be executed whenever a subroutine jump is made to a nonexistent ROM. This same feature is also used for the diagnostic ROM. Whenever the CPU first turns on, the firmware executes a subroutine call to a fixed-address diagnostic ROM. If the diagnostic ROM has been plugged into one of the HP-41C's ports, it takes over; otherwise, control is returned to the mainframe microcode. (The diagnostic ROM is a tool developed to help HP service technicians troubleshoot a malfunctioning HP-41C. This ROM is not available to customers.)

Acknowledgments

Those responsible for the integrated circuits used in the HP-41C are Donald Reid for the CPU, Henry Koerner for the display driver, and Peter Yu for the ROM. Major contributors to the mechanical package include Dave Scribner, Jerry Steiger, Rick Nelson, and Bill Grace. Rich Whicker contributed to the development of the display. Bill Egbert

SPECIFICATIONS

HP-41C Calculator

Functions

ALPHA STRING CONTROL: Keyboard alpha mode selection; alpha mode off; alpha mode on; alpha recall; alpha shift left; alpha store; alpha view; append; clear alpha register; compare strings; execute.

AUDIBLE BEEPER CONTROL: Beeper; tone of beeper.

CONDITIONAL: $X=Y?$, $X=0?$, $X>Y?$, $X>0?$, $X<Y?$, $X<0?$, $X\leq Y?$, $X\leq 0?$, $X\neq Y?$, $X\neq 0?$.

CONVERSIONS: Decimal to octal; degrees to radians; hours (decimal) to hours, minutes, seconds; hours, minutes, seconds to hours (decimal); octal to decimal; polar to rectangular; rectangular to polar.

DISPLAY: Append display; clear display; engineering notation; fixed point; scientific notation.

EDITING: Back step; clear program; correction key; delete program memory lines; go to line number; go to program name; single step.

FLAGS: Clear program flag; "flag clear" test; "flag clear" test and clear; "flag set" test; "flag set" test and clear; set program flag.

MATHEMATICS: Addition, antilogarithms (common and natural); division; exponential (y^x); logarithms (common and natural); multiplication; percent; percent of change; pi; reciprocal; square; square root; subtraction.

MISCELLANEOUS: Advance paper; power off; keyboard power on/off; power on (continuous); shift.

NUMBER ALTERATION: Absolute value; change sign; enter exponent; fractional portion of number; integer portion of number; modulo function (remainder); round; sign of x.

PROGRAMMING: Decrement and skip if equal; end of program; execute subroutine; go to; go to end of program; increment and skip if greater; label program; pack program memory; pause; program mode selection; prompt; return; run/stop; stop.

STACK CONTROL: Clear stack; clear X-register; enter; exchange X and any register; exchange X- and Y-register; roll down; roll up; recall into stack; store into stack.

STATISTICS: Accumulation correction; accumulation; clear statistics registers; factorial; mean; standard deviation; statistical register block specification.

STORAGE: Clear all storage registers; LAST-X register recall; recall; size of register configuration store; storage register addition, division, multiplication and subtraction; view register contents.

TRIGONOMETRY: Arc cosine; arc sine; arc tangent; cosine; degrees mode; grads mode; hours, minutes, seconds addition and subtraction; radians mode; sine; tangent.

USER DEFINED: Assign; catalog list; copy; user mode selection.

PHYSICAL SPECIFICATIONS:

LENGTH: 14.4 cm.
 HEIGHT: 3.3 cm.
 WIDTH: 7.9 cm.
 WEIGHT: 210 g.
 OPERATING TIME: 9 to 12 months (battery life dependent upon use; less with plug-ins).
 OPERATING TEMP: 0° to 45°C.

OPTIONAL PERIPHERALS AND MODULES: Memory Module with instruction card. Card Reader with owner's manual. Printer, complete with two rolls of paper, rechargeable batteries, recharger and owner's manual. Wand, with owner's manual (available early 1980).

APPLICATION PACS

Mathematics	Real Estate
Statistics	Games
Financial Decisions	Aviation
Surveying	Thermal and Transport Science
Securities	Home Management
Stress Analysis	Navigation
Circuit Analysis	Structural Analysis
Machine Design	Clinical Lab and Nuclear Medicine

SOLUTION BOOKS

Test Statistics	Optometry II (Contact Lens)
High-Level Math	Fluid Dynamics and Hydraulics
Home Construction Estimating	Solar Engineering
Cardiac/Pulmonary	Antennas
Lending, Saving and Leasing	Control Systems
Electrical Engineering	Surveying
Mechanical Engineering	Physics
Civil Engineering	Calendars
Business Statistics/Marketing/Sales	Real Estate
Chemical Engineering	Small Business
Geometry	Heating, Ventilating and Air Conditioning
Games	Chemistry
Optometry (General)	

MEMORY AND APPLICATION MODULES:

LENGTH: 3.2 cm.
 HEIGHT: 1.0 cm.
 WIDTH: 2.9 cm.
 OPERATING TEMP: 0° to 45°C.

CARD READER:

LENGTH: 7.29 cm.
 HEIGHT: 3.52 cm.
 WIDTH: 7.93 cm.
 WEIGHT: 92 g.

OPERATING TEMP: 10° to 40°C.

OPTIONAL BLANK MAGNETIC CARDS: 40 Card Pac with Holder, 120 Card Pac with Holders, 1000 Card Pac.

PRINTER:

LENGTH: 13.2 cm.
 HEIGHT: 6.2 cm.
 WIDTH: 17.8 cm.
 WEIGHT: with paper and battery, 770 g.
 OPERATING TEMP: 0° to 45°C.
 RECHARGER POWER REQUIREMENTS: 7W.
 CHARGING TEMP: +15° to 40°C.
 CHARGING TIME: on-17 hr; off-6 hr.
 OPERATING TIME: 3-6 hr.
 OPTIONAL ACCESSORIES FOR PRINTER: Thermal Paper, Security Cable, Recharger, Battery Pack, Reserve Power Pack.
 PRINTING SPEED:
 6-CHARACTER LINES: 120 lines/minute.
 20-CHARACTER LINES: 100 lines/minute.
 MAXIMUM 24-CHARACTER LINES: 70 lines/minute.

WAND:

LENGTH: 13 cm.
 HEIGHT: 1.8 cm.
 WIDTH: 2.3 cm at widest.
 WEIGHT: 55 g.
 OPERATING TEMP: 0° to 45°C.

PRICES IN U.S.A.: HP-41C Calculator, \$295. 82104A Card Reader, \$195. 82143A Printer, \$350. 82106A Memory Modules, \$45 each. 00041-15001 Standard Application Module, \$30.

MANUFACTURING DIVISION: CORVALLIS DIVISION

1000 N.E. Circle Boulevard
 Corvallis, Oregon 97330 U.S.A.





Bernard E. Musch

Bernie Musch's HP career parallels the history of HP personal calculators. He joined the company in 1970 and helped design the HP-35, the first HP handheld calculator. He contributed to the HP-55 and HP-65, served as project manager for the HP-91, and since 1976 has been section manager for various handheld calculators including the HP-41C. He's authored several papers, most recently on the calculator business, and generated several patents in the areas of mechanical design and calculators. He received his BSME degree from Lehigh University in 1964 and his MSME and

PhD degrees from Stanford University in 1966 and 1970. Born in Baltimore, Maryland, Bernie is married, has two sons, and lives in Corvallis, Oregon. He's interested in music and sports, is active in the American Youth Soccer Association, and serves as scoutmaster of the local Boy Scout troop.

John J. Wong



Mainland China is the birthplace of John Wong, who came to California in 1963 and to Hewlett-Packard ten years later, following his graduation from the University of California at Berkeley with a BS degree in electrical engineering. John developed several integrated circuits for the HP-25, HP-25C, and HP-27 Calculators before becoming project leader for the HP-41C. He later took over responsibility for all of the HP-41C electronics as project manager. John, who lives with his wife and two children in Corvallis, Oregon, spends his spare time doing electronics projects at home

and exploring his interest in photography and hi-fi stereo.

was the guiding spirit of the HP-41C firmware. Other members of the firmware team were Steve Chou, Gaye Daniels, Ray Davis, Greg Filz, Bob Worsley, and Dennis York. The



David R. Conklin

Dave Conklin started his career with HP in 1975, then resigned to move to Corvallis, Oregon, only to join HP again when the calculator division moved to that city. While with HP's Santa Clara Division, he was a quality assurance systems engineer and a programmer on the 5420A Digital Signal Analyzer. At the Corvallis Division, he first worked with the firmware team for the HP-41C, then became project manager for the 41C follow-ons in 1979. Dave's BA degree in mathematics is from the University of California at Berkeley (1967), and his MS degree in computer science was

completed in 1975 at the University of Santa Clara. Dave has also worked in programming and systems analysis for nuclear power plants and computer-controlled sawmill systems. A member of ACM and IEEE, Dave is married and lives in Corvallis. Raising mules and applying programmable calculators to problems in pharmacokinetics are among his leisure time activities.

math algorithms were adapted for the HP-41C by Dennis Harms and Tony Ridolfo. Ed Liljenwall was the industrial designer. Roger Quick managed the project single-handedly in its early stages. Special thanks must go to Max Schuller, whose experienced hand stabilized our course during the final push into production. Bernard Tsai was and is our production engineer. Ray Tanner wrote the HP-41C manual. In addition, there were many individuals outside the product development team without whose able assistance we could not have succeeded.

References

1. T.M. Whitney, F. Rodé, and C.C. Tung, "The 'Powerful Pocketful': an Electronic Calculator Challenges the Slide Rule," Hewlett-Packard Journal, June 1972.
2. M.J. Cook, G.M. Fichter, and Richard E. Whicker, "Inside the New Pocket Calculators," Hewlett-Packard Journal, November 1975.

Card Reader Offers Compatibility and Expanded Capability

by David J. Lowe and Patrick V. Boyd

MODEL 82104A CARD READER, an accessory to the HP-41C Calculator, is an adaptation of the card reader design used in the HP-65, 67, and 97.^{1,2} This design has proved effective and provides compatibility

between the HP-41C and the HP-67/97. Thus the large software library of HP-67/97 programs is a great asset for the HP-41C.

A basic consideration in the 82104A design was that the

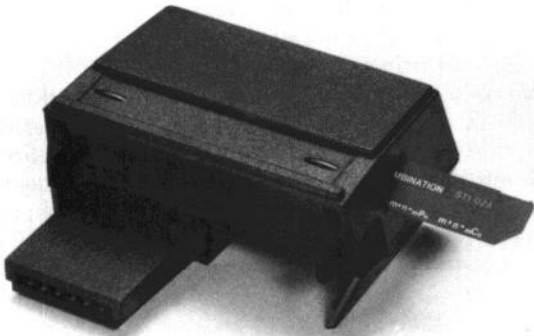

Fig. 1. Model 82104A Card Reader plugs into the HP-41C. It will read HP-67/97 magnetic cards as well as HP-41C cards.

card reader be small enough to plug onto the HP-41C and become an extension of its package, simulating the built-in card reader of the earlier calculators but having the flexibility of an accessory that can be purchased separately and removed at will (see Fig. 1).

HP-67/97 Compatibility

The new card reader will read cards written on an HP-67 or 97 but an HP-67/97 will not read cards written on the 82104A. When the 82104A is plugged into the HP-41C it adds several new functions to the function library of the HP-41C, much as new functions are added by plugging in application modules. Among the card reader functions is the translation routine used to convert HP-67/97 cards. This routine is transparent to the user and cannot be executed from the keyboard. It is automatically executed when an HP-67/97 card is inserted.

The first information read from a card allows the calculator to decide how to process the rest of the data on the card. In the case of an HP-67/97 card the translation routine is executed. Not every HP-67/97 function has a corresponding HP-41C function and vice versa. When an HP-67/97 function and an HP-41C function are close enough the translation routine modifies the HP-67/97 function to make it an HP-41C function. An example is the HP-67/97 function $X \leq I$. In the HP-41C there is no register designated I. Any register can be used as an indirect register. When the translation routine comes across an $X \leq I$ it replaces the I with register 25, which can be used as an indirect register. Because the translation routine automatically makes these changes it may be necessary to change the user instructions of some HP-67/97 programs. User instruction changes for HP-67/97 application pacs are outlined in an appendix of the 82104A Owner's Handbook.

In some cases neither a direct translation or a modification would allow an HP-67/97 function to be converted to an HP-41C function. An example is display formatting. On an HP-67/97 you specify the type of display: fixed decimal point, engineering, or scientific notation. Then in a separate process you specify the number of significant digits or

digits after the decimal point. On an HP-41C you specify both the type of display and the number of digits in the same set of keystrokes. It was necessary, therefore, to allow for HP-67/97 programs adjusting the significant digit count without changing the display type. This was done by adding these functions to those in the HP-41C mainframe. Whenever you plug an 82104A into an HP-41C you add a new set of functions that are direct implementations of HP-67/97 functions that could not otherwise be translated.

Hardware Improvements

In the process of adapting the HP-65/67/97 card reader design to the HP-41C an effort was made to improve on as many features of the design as possible. One of these improvements involved the switches that detect the position of the card as it passes through the card chamber. In the old design, space was at a premium, forcing the switches to make very little movement in going from open to closed position. The switches had to be carefully adjusted as they were installed in the factory. The 82104A overcomes this problem of switch adjustment with a new switch design that uses buckling columns instead of cantilever beams (Fig. 2). The actuating motion of the switches is greatly increased, making adjustments unnecessary. The switches are independent (separate) to avoid the coupling problem of the earlier design, which incorporated all the switches in the same piece of metal.

The requirement that any 82104A plug into any HP-41C dictated another improvement, this one in the control of the motor speed. The subtle differences in HP-41Cs make it mandatory that the card reader itself maintain tight tolerances. Where the previous motor speed control was open-loop, the new design closes the loop, providing feedback control. The principle is the same as that used to control the motor speed accurately in the printer of the HP-97. The motor is driven with a pulse train, and the pulse duty cycle is varied by the feedback loop, maintaining constant speed even when the load on the motor varies.

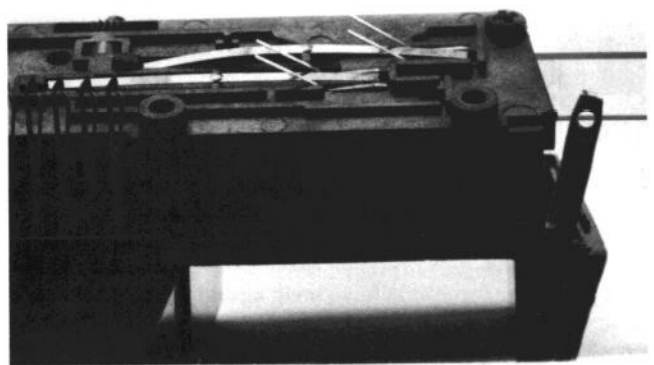

Fig. 2. A new card-detection switch design eliminates critical adjustments.

Minimizing Power

Power consumption was a major consideration. While the HP-41C uses very little power, the card reader with its motor and circuitry to drive the magnetic head consumes large amounts of power. To cut power consumption to a minimum, the circuits that use the most power are powered only when a card is in the card chamber. The switch that indicates the presence of a card is also a power switch. Thus, the time that the card reader is drawing energy from the batteries is measured in seconds instead of weeks.

Besides the problem of average power, there is the problem of peak power, such as the power surges required to start the motor. Accommodating these peak drains on the battery required the isolation of all circuits that were sensitive to dips in battery voltage.

Low-Battery Software Control

To further extend card reader usability with a set of old batteries, software controls power use by pulsing the motor. When the batteries approach the low-battery state, software begins to turn off the motor for short periods of time to lower the motor duty cycle and decrease power consumption, giving the batteries more time to recover between pulses. As the battery voltage drops lower and lower the motor off time increases. Even though the motor is being turned off for short periods as the card goes through, it is easily possible to have a correct read, and the difference may even be imperceptible to the user. The 82104A verifies a good read on every card by computing a checksum during each card pass and comparing it to the sum recorded in the last 28 bits of information on the data track. To tell the user what is happening, the message LOW BAT is displayed at the end of any read in which the motor has been turned off, whether the read was good or bad. Many good reads may be possible when the batteries are in this condition.

Because there is no way for the calculator to check to make certain that the information it tried to write on a card got recorded correctly, there is a chance that bad or incomplete information could be written when the motor is pulsed under a low-battery condition. To be safe, therefore, the calculator aborts a write session as soon as it is discovered that the batteries may be too low to complete the write under normal conditions.

Writing consumes more power than reading. Because of the internal impedance of the batteries, they appear to be at a lower voltage during a write than during a read. This means that, even though there is not enough energy in the batteries to finish a write operation, there may still be enough for several more successful reads. Internal impedance of the batteries also accounts for the ability of the calculator to operate well after the batteries have discharged below the point where they will operate the card reader.

New Functions

Several new functions have been added to the 82104A to make it more powerful and useful than its predecessors. Programs may be executed automatically as they are read in. If Flag 11 is set when a program is recorded on a card, that program is marked for automatic execution. Thereafter, each time the program is read in, it will begin to execute as

soon as the read is completed.

Data cards will hold 16 registers per side, or 32 per card. The data may be taken from or returned to any portion of data memory, as directed from the X register (display) with the WDTAX and RDTAX functions.

The status of flags and key assignments of the HP-41C can be preserved using the WSTS function. The flags are recorded on the first card side, and key assignments are recorded on subsequent sides as necessary. The display prompts the user for the appropriate number of cards using the format RDY kk of nn, where nn is the total number of card passes (tracks) required to complete the sequence and kk is the lowest unread track number (a track is one side of a card). The prompt is displayed in both read and write sequences. Write sequences can be aborted at any time without memory loss. RSTS can be aborted after the first (flags only) card pass without penalty. If desired, all RAM registers (80 in the mainframe, 64 per module) may be dumped onto cards using the WALL function.

Cards are protected from accidental overwriting by the traditional corner clip. However, protected cards may be overwritten by setting Flag 14 (SF14) before initiating a write sequence. The flag is automatically cleared if the sequence is either completed or aborted.

Cards can be verified for proper data and identification by executing the VER function. Each card will be identified as to type (HP-67, status, program, data, WALL) and track number (1-15), and the checksum verified to insure that a proper write has taken place. VER does not alter any status,

David J. Lowe

After completing his BSEE degree at Utah State University in 1975, Dave Lowe joined HP's Corvallis, Oregon Division. His responsibilities with HP have included investigation of the HP-41C wand bar code reader and electronic design for the HP-41C card reader. Dave is married, has a son, and resides in Corvallis. In his spare time, he enjoys woodworking, his home computer, soccer and basketball playing.



Patrick V. Boyd

Pat Boyd was born in Reedsport, Oregon and attended Oregon State University, graduating in 1973 with a BSME degree. After three years doing mechanical design of tractor winches and forklift trucks, he joined HP in 1976 and contributed to the mechanical design of the card reader for the HP-41C Calculator. He's a member of ASME and a registered professional engineer in the State of Oregon. Having recently left HP's Corvallis Division, Pat now lives in Battle Creek, Michigan. He's married and has a son and a daughter, and if his children take up most of his spare time, that's just fine with Pat, who thinks that "nothing else gives such a large return on investment" as keeping a couple of children "healthy, happy and growing straight."



data, or programs in the calculator. The check that is made is the same as that made during a read. By using VER, it is possible to insure that a card will read in properly without disturbing the calculator.

Acknowledgments

Special thanks go to Dennis York and Steve Chou for their help with this article. Dennis was responsible for the software translation routines that give the 82104A compatibility with the HP-67/97 card readers. Steve's responsibility was the software for the remaining routines. These include the functions the user accesses during card reader use. Others involved in the design of the 82104A were Tom Peterson, who worked on the case design, George Custer,

who helped keep us organized in the final stages of the design, Bill Buskirk, who assisted in the electrical designs, and Bond Ying, who assisted with the CMOS ICs. Charlie Allen was the industrial designer. Recognition should also be given to the numerous support people who made it possible to get this product into production.

References

1. R.B. Taggart, "Designing a Tiny Magnetic Card Reader," Hewlett-Packard Journal, May 1974.
2. P.D. Dickinson and W.E. Egbert, "A Pair of Program-Compatible Personal Programmable Calculators," Hewlett-Packard Journal, November 1976.

Evolutionary Printer Provides Significantly Better Performance

by Roger D. Quick and Donald L. Morris

PRINTED OUTPUT is a highly desirable adjunct to a programmable scientific calculator. As computing power, program length, data capacity, and communication ability all increase, a printed record becomes a necessity for many users of such calculators.

As the power of the calculator increases, so must the abilities of the corresponding printer. To give the user maximum flexibility, a peripheral printer was chosen for the HP-41C. This separation gives the user the portability of a handheld calculator and also maintains briefcase portability for the calculator/printer system. The new printer, Model 82143A, Fig. 1, contains its own rechargeable batteries, and measures $18 \times 13 \times 6$ cm.

With earlier HP programmable printing calculators, such as the HP-97,¹ the printer was able to record numbers, listings of programs, and the trace of an executing program. The 82143A Printer makes these records and more. It can label numeric output with meaningful words and phrases, has access to 127 standard characters, makes normal and condensed program listings, can create its own characters, and gives the HP-41C user a graphics capability through the printer's plotting functions. Thus the 82143A adds functional capabilities to the HP-41C system in addition to its normal printed record function.

The 82143A printer is similar to other HP-41C accessories in that the mainframe calculator is not burdened, either in ROM space or in execution time, by the existence of accessories. When the printer is plugged in, firmware in ROM is added to the HP-41C system bus. This additional system ROM is contained in the 82143A module that plugs into the HP-41C. Thus connected, the printer adds 24 functions to the mainframe's repertoire, and has access to all capabilities

of the mainframe. This closely linked architecture makes it possible for the HP-41C to display printer error messages, to treat the PRINT key on the printer as if that key were on the HP-41C keyboard, and to have HP-41C functions such as AVIEW print whenever there is an operational printer attached. These friendly capabilities give the HP-41C/82143A system attributes similar to a package-integrated system like the HP-97 without assuming that all users want all the pieces all the time.

Printer Features

The printer has its own power light and a low-battery light. A portion of the printer ROM is under calculator processor control, allowing the HP-41C Calculator display to be used to output printer messages, such as OUT OF PAPER or PRINTER OFF when an attempt is made to execute a printer function under such conditions. The printer also has a five-position print intensity control switch that allows the user to adjust the print density by direct control of the voltage applied to the printhead.

The new printer is much faster than earlier designs. The improvement was accomplished by means of an encoder feedback loop, a sophisticated printhead drive, and a soft printing platen behind the paper. Also, a significant improvement in program listing speed was obtained by giving the user the choice of three program listing formats.

Program listings can be generated by the functions PRP and LIST. PRP prints the whole program and LIST prints only the specified part of a program. Both PRP and LIST can generate all three formats: left justified, right justified (which is faster and allows labels to be found more easily), and a condensed format that prints several program steps



Fig. 1. The printer for the HP-41C Calculator is an accessory that plugs onto the calculator.

per printed line and results in program listing speed of about three times that of the other options.

Several advanced printer functions are programmed into the new printer. By setting Flag 12 on the HP-41C, the printer can be put in the double-wide mode. While in this mode the columns of dots making up the 5×7 dot matrix letters are each printed twice. Thus the printed characters are twice as wide as the normal printing mode. Lower-case letters can be printed by setting Flag 13 on the HP-41C.

Customized Printing

The new printer's four accumulate functions allow the printer's internal RAM to be used as a buffer for characters to be printed. In this way characters can be transferred from the HP-41C into the printer at any time during program execution.

The accumulate X and accumulate alpha functions (ACX and ACA) transfer the contents of the X or alpha registers to the printer buffer. This function allows mode changes within a printed line. Characters can be changed from upper-case to lower-case or from normal to double-wide. For example, if the name "James" were to be printed, the "J" would first be sent to the printer buffer from the calculator using the accumulate alpha function. The lower-case mode, Flag 13, would then be set before the "ames" is accumulated to the printer buffer. The accumulate X function can be used to print several numbers on the same line to format columns of numbers as output. The accumulate X function can also be used in conjunction with the accumulate alpha function to produce a mixed format of alpha and data—for example, "PRICE = \$50.00."

The accumulate character function (ACCHAR) allows access to characters (Greek, European, etc.) not directly acces-

sible from the HP-41C keyboard. This function can be used with other accumulate functions—for example, "R1 = 62KΩ" or "COST = £ 50."

The accumulate column function (ACCOL) gives the user complete control over the printed output. With this function the columns making up the character dot matrix can be controlled individually, allowing the user to define up to 43 columns per line. These columns of print can be used to define unique symbols or characters, for example, "♠ ♡, ♣ ♦," or "【hp】."

Another way to define special characters is by means of the functions BLDSPEC and ACSPEC. These allow the user to create and print characters consisting of any desired pattern of dots on a 7×7 matrix. Once created with BLDSPEC, these special characters can be stored in data registers in the HP-41C. The Japanese character set shown in Fig. 2 was created with BLDSPEC. In a standard character the outside columns of the 7×7 dot matrix are blank, but special characters using all seven columns can be placed adjacent to each other to form larger characters or to do graphics, as shown in Fig. 3.

PRPLOT is an interactive plotting function that asks for the name of the function to be plotted and the plot scaling information and generates a complete labeled plot of the function. PRPLOT is a noninteractive version of PRPLOT that takes its information from registers in the HP-41C. The functions PRAXIS, REGPLOT, and STKPLOT help the user construct customized plots of single-valued functions. A special (user-defined) character may be used with any of these plotting functions. The function SKPCOL allows the spacing of characters to column-position resolution (maximum field width is 168 columns). This is useful for plotting functions and for positioning graphics or labels.

0	ア	22	ヌ	43	ワ
1	イ	23	ネ	44	ヰ
2	ウ	24	ノ	45	ヱ
3	エ	25	ニ	46	ヰ
4	オ	26	ヒ	47	イ
5	カ	27	フ	48	ロ
6	キ	28	ハ	49	ヘ
7	ク	29	ホ	50	オ
8	ケ	30	マ	51	カ
9	コ	31	ミ	52	ク
10	サ	32	ム	53	コ
11	シ	33	メ	54	セ
12	ス	34	モ	55	ー
13	セ	35	ト	56	・
14	ソ	36	リ	57	□
15	タ	37	ロ	58	○
16	チ	38	ラ	59	△
17	ツ	39	リ	60	▽
18	テ	40	ル	61	◇
19	ト	41	レ	62	◇
20	ナ	42	ロ	63	¥
21	ニ				

Fig. 2. Printer has functions that allow the user to define special characters like this Japanese character set.

Inside the 82143A

The 82143A is a battery-operated thermal printer capable of delivering 24 characters per line at a scan rate of 60 characters per second while acting as a peripheral device to the HP-41C Calculator system. The nominal line rate of the printer varies from 130 lines per minute for lines of 10 characters or less to 70 lines per minute for 24-character lines. Communication between the 82143A and the controlling HP-41C is accomplished through a seven-line serial interface.

Fig. 4 is the printer block diagram. The power system centers on a variable voltage source (14-18 volts), which drives the thermal printhead at a power level selected by the user-adjustable print intensity switch. An additional fixed five-volt supply provides power to the microprocessor and other internal logic. A rechargeable nickel-cadmium battery acts as the energy storage medium. Power-on circuitry protects the thermal printhead from excessive power during turn-on.

The HP-41C Calculator and the 82143A Printer are linked together via the calculator's plug-in module, which contains the printer ROM chip and the interface chip. The hub of the printer electronics is the 3870 microprocessor, which performs such functions as interfacing with the HP-41C, monitoring the front control panel, processing the encoder and home switch signals, and driving the printhead and the dc motor. The internal structure of the 3870 includes a CPU section, 2K of designer-programmable ROM, 64 bytes of RAM, and both a timer and an external interrupt. The microprocessor requirements of the 82143A printer use all of the 3870's capabilities.

How It Prints

The 3870 microprocessor stores within its line buffer all

the characters and commands transmitted by the HP-41C. The line buffer is organized as a 42-byte, first-in first-out buffer and may contain any number of printable lines. As information contained in a particular buffer location is used during printing, the buffer location is immediately available for new incoming data, thus creating a pipeline effect. Whenever this buffer contains a printable line, the 3870 applies a forward drive signal to the motor causing the printhead to move leftward away from its home position (located on the right side of the mechanism with the home switch closed). As the home switch opens, the microprocessor computes whether any leading blank columns are required during this printed line. Each column across the paper is synchronized with an external interrupt pulse generated by the rotary encoder. At the appropriate column, the 3870 recalls from its line buffer the character to be printed and looks up the corresponding character pattern one column at a time.

The thermal printing is accomplished by the active heating and passive cooling of seven individual printhead resistors, each powered by a high-current driver controlled by a microprocessor line. The controlled pattern of turning each resistor on or off as the printhead scans across the paper generates the characters one vertical column at a time. The printing time for each column commences with an encoder pulse and halts a fixed time later (1.2 ms). This technique makes critical control of the printhead speed unnecessary, since the encoder guarantees no error accumulation from

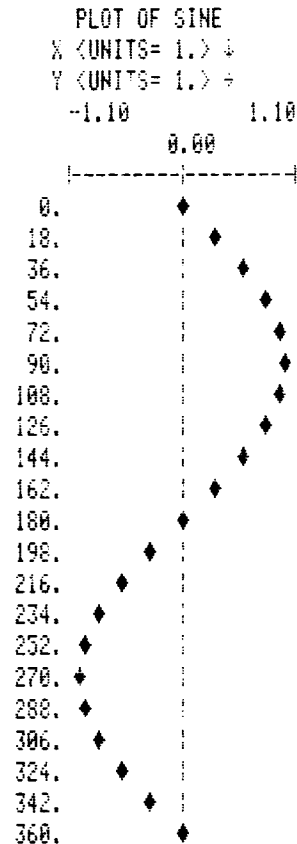

Fig. 3. Special characters can be used for graphics, as shown here.

one column to the next.

The microprocessor controls the forward linear printhead speed by holding the time between consecutive encoder pulses constant (2.4 ms). Depending on the last time between encoder pulses, the motor either remains on, is turned on (too slow), or is turned off (too fast) until the next encoder pulse occurs. Whenever a printed line is completed, the microprocessor brakes the motor and then applies a constant reverse motor signal driving the printhead towards its home position at maximum speed. Once the home switch closes, the 3870 brakes the motor and awaits future printing. On the return stroke, a mechanical system advances the paper in preparation for the next line. This mechanical paper advance requires a minimum linear printhead travel of ten character positions for any line.

Variations of normal character printing occur if any combination of the printer's special modes is active. If the double-wide mode is selected, all columns, printed or blank, assume a width of two encoder pulses, resulting in a maximum of 12 double-wide characters per line. Whenever the lower-case alpha mode is active, any normally upper-case alpha character is converted to its lower-case equivalent. During column printing, the data contained in the 3870's line buffer no longer represents a character, but instead represents a binary-coded combination of resistor dots to be printed during a particular column. Since the commands that activate these special modes are stored in the 3870's line buffer, a number of different modes may appear in any one printed line.

Print Quality

Print quality in any printing system is a subjective characteristic. However, several key parameters can be identified that, we think, always contribute to overall quality.

A subtle but very desirable characteristic in a dot matrix system is consistency of column-to-column spacing within a character. This is enhanced in the 82143A by an optical position encoder consisting of a light emitter-detector pair,

a reflective wheel, and a comparator. Since linear head motion is mechanically linked to the rotary motion of the reflective wheel, pulses generated by the encoder correspond to equal head-position intervals. The length of these intervals is determined by the angular distance between teeth on the reflective wheel and is set so that a pulse occurs each time a column should be printed. In addition to maintaining column-to-column spacing within a character, the encoder also guarantees character-to-character spacing consistency because intercharacter distance is an integral multiple of column spaces. The mechanical home switch on the printer mainframe provides synchronization for line-to-line alignment of characters, thus preventing margin irregularities.

At the high printing speeds of the 82143A the elements of the printhead do not have time to cool between column times. If equal power were applied for the first and succeeding pulses, thermal integration would cause the following dots to be darker than the first. To avoid this problem, the 3870 processor shortens the pulse width and thus the total energy applied to previously fired resistors. This reduction in energy results in nearly equal peak element temperatures and consistent dot development regardless of the printhead's history.

Since the quality of dot development relies very heavily on good head/paper contact, a prime focus of design activity was the soft platen for the 82143A. The soft platen provides a pliable surface to allow intimate contact between the paper and printhead. A die-cut strip of 0.8-mm-thick silicone rubber was chosen for the platen because of its excellent resilience and negligible plastic set over the full operating temperature range. It is backed up by an extruded aluminum platen support that is flat and stable under all operating conditions. The two are bonded together by a self-leveling adhesive. A thin piece of TFE-impregnated fiberglass cloth is draped over the platen surface, allowing the paper to pass between the scanning printhead and the silicone rubber platen without sticking.

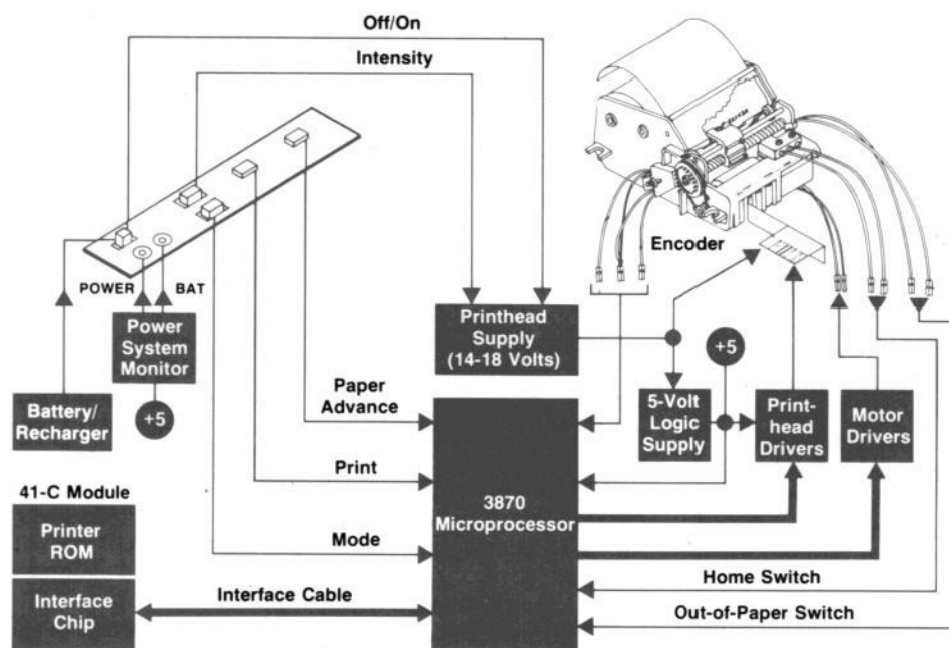

Fig. 4. Printer block diagram. The five-position intensity control allows the user to adjust the print density by controlling the printhead voltage.

Speed

A critical factor limiting printing speed is the thermal response time of the printhead. For short times (1-5 ms), the thermal conductivity and capacity of the glaze material on the printhead determines the time lag between the command to print and the appearance of the mark on the paper. Reducing the thickness of the glaze barrier proportionately increases its conductivity and decreases its capacity, thus lowering both the heating and cooling time of the elements and enabling higher print speeds. On the other hand, a thinner glaze results in a lower peak asymptotic temperature and forces an increase in input power to achieve printing temperature. The 82143A compromises by making the glaze thickness 0.038 mm, half that of the HP-97. Response time was decreased by a factor of four with very little additional input power required.

If the low-voltage (5V battery) printhead drive scheme in the HP-97 had been scaled to handle the increased current levels required for the 82143A's higher print speed, the internal impedance of the battery, transistor saturation voltages, and transistor base currents would have posed efficiency problems. For these reasons, the printhead resistance was changed from 10 ohms to 85 ohms and a switching power supply was added to raise the nominal printhead voltage from 5 volts to 16 volts. Since a large output filter capacitor (1000 μ F) supplies peak printhead currents, the 16-volt power supply need only deliver average current, thus reducing maximum battery current from peak to average. In addition, the combination of higher printhead voltage and resistance reduces current levels, allowing smaller and cheaper drivers. These design modifications more than

STANDARD CHARACTER SET:

```

*  ¨  †  ‡  §  ¶
↓  Δ  σ  †  λ  μ
<  †  ‡  §  ¶  δ
À  á  Ä  å  Ö  Ö
0  Ü  Æ  œ  †  £
%  &  '  (  )  *
+  ,  -  .  /  0
1  2  3  4  5  6
7  8  9  :  ;  <
=  >  ?  @  A  B
C  D  E  F  G  H
I  J  K  L  M  N
O  P  Q  R  S  T
U  V  W  X  Y  Z
[  \  ]  ^  _  `
a  b  c  d  e  f
g  h  i  j  k  l
m  n  o  p  q  r
s  t  u  v  w  x
y  z  π  |  →  Σ
†

```

Fig. 5. Standard HP-41C printer character set.

Roger D. Quick



Roger Quick stayed in his native Berkeley, California, long enough to get his BA degree in mathematics in 1964 from the University of California there, then traveled south to Stanford University where he did graduate work in electrical engineering. In 1975 he came to Hewlett-Packard, where he has been project manager for several HP-41C projects, including midrange peripherals, the 82143A Printer, and the HP-41C software and electronics. He also served as project leader for the HP-19C and HP-10 electronics. Before joining HP, Roger was with a calculator company for five years and with a major semiconductor company for another five years. He is a member of the Association for Computing Machinery and lives in Corvallis, Oregon. He and his wife enjoy camping and hiking. Roger trains Labrador retrievers and is rebuilding a "basket-case" Lotus sports car.

Donald L. Morris



Don Morris found his way to HP in 1973 via Bradley University, where he received his BSME degree in 1971, and the University of Illinois, where he received a BSEE degree in 1973. His work at HP has included printed circuit engineering, project leader on the 82143A, and currently, project manager with the Corvallis Division. Born in Lincoln, Illinois, Don is married and lives in Corvallis. His 5-month-old son occupies most of his time, according to Don, but he still finds time to build furniture, play folk guitar, and compete in go-kart racing. Don designed and

acted as contractor for his home in Corvallis.

compensate for the 20% efficiency loss in the switching power supply. In addition, the output voltage of the power supply is switch programmable, providing the user with a print intensity control.

Noise

Due to the increased printhead velocity, the gear drive from the HP-97 would have generated an unsatisfactory noise level. To overcome this potential problem, the gear drive has been replaced by a new reduction drive that links the motor pulley to the lead screw pulley via a molded ethylene propylene O-ring belt. This belt eliminates gear chatter and passes extensive environmental and life tests without breaking or deteriorating.

Further noise reduction has been achieved by lowering the frictional forces and improving the wear characteristics of the mechanical system. Applying a break-in oil to all moving parts at assembly reduces start-up friction and extends mechanism life by ensuring uniform wear-in. To minimize frictional drag, the material of the printhead carriage has been changed to a TFE-and-silicone-filled nylon, and a self-lubricating acetal thrust washer has been inserted between the aluminum pulley and the plastic

printer housing.

Acknowledgments

We would like to thank Tom Braun, Bill Schafer, Dave Shelley, and Bob Worsley, who contributed portions of this article. The 82143A benefited from the creativity and contributions of many people. Terry Bradley and Bill Schafer were responsible for the mechanical design. Tom Braun wrote the 3870 microcode, and with Gary Siewell, was

responsible for the development of the printhead. The system electronics were the work of Dave Shelley. Charles Tan designed the CMOS interface integrated circuit. The HP-41C microcode was written by Bob Worsley. Chuck Dodge was the industrial designer.

Reference

1. B.E. Musch and R.B. Taggart, "Portable Scientific Calculator Has Built-in Printer," Hewlett-Packard Journal, November 1976.

Bulk CMOS Technology for the HP-41C

by Norman L. Johnson and Vijay V. Marathe

COMPLEMENTARY METAL-OXIDE semiconductor (CMOS) technology plays an important role in many recent HP products. Most of these products use the silicon-on-sapphire (SOS) form of this integrated circuit technology. However, there is another form: bulk CMOS or CMOS-in-silicon.

Recognizing the need for a very-low-power IC technology for its handheld calculators, HP's Corvallis Division undertook development of a bulk CMOS process jointly with the integrated circuits laboratory of HP Laboratories, HP's central research facility. Two handheld calculators, the HP-29C and the HP-19C, have used a CMOS memory chip fabricated at HP Laboratories.

The new HP-41C represents the first full-scale HP application of this bulk CMOS process. To fabricate the HP-41C chip set, a modern, automated facility controlled by a central process control system has been set up at the Corvallis Division. Computer-controlled diffusion furnaces tied to the central computer are used extensively, providing precise control of the diffusion/oxidation steps for high-volume production. These furnaces also lend themselves to quick process modifications when required.

The major advantage of CMOS is its very low power dissipation, particularly in standby mode: a CMOS chip can

retain data with its operating voltage reduced drastically. In this state the current drawn from the power supply is just the reverse-bias leakage currents of the semiconductor junctions. CMOS also has an inherent speed advantage over its cousins, PMOS and NMOS, because both kinds of active MOS devices, P-channel and N-channel, are present. Thus a node can be actively pulled either up to $+V_{cc}$ or down to ground. Another advantage is that studies have shown that the duty cycle of a typical CMOS node within a calculator processor chip is only about 1%, even in an operating mode; this helps minimize power consumption in that mode. All of these factors contribute to long battery life in a calculator using CMOS chips.

A disadvantage of CMOS is its packing density. The number of gates per square millimeter is lower in CMOS than in NMOS or PMOS. This mainly affects the system partitioning. CMOS processing is also inherently more complicated than either NMOS or PMOS processing. Special techniques developed for the CMOS process used in the HP-41C are aimed at reducing the impact of both of these disadvantages.

Process Description

HP's bulk CMOS process uses local oxidation of silicon to

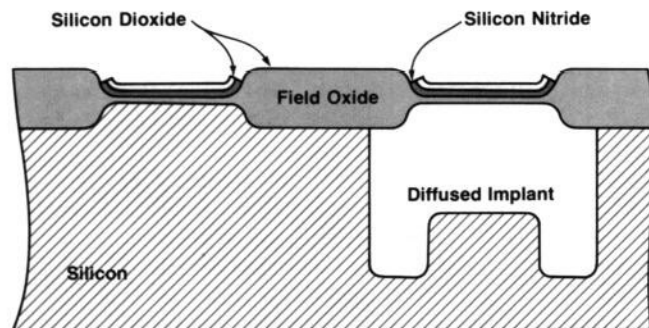

Fig. 1. CMOS integrated circuit production begins with implant drive-in and field oxidation steps.

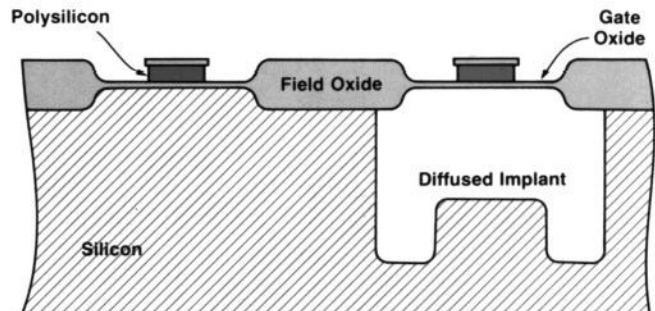

Fig. 2. Polysilicon gate definition is next. Then the gate oxide is etched away and the P+ and N+ source and drain diffusions are done (see Fig. 3).

attain a more planar topology that lends itself to easy metal coverage and to maximize device density. Without local oxidation another masking step would be required, and P+ and N+ guard rings would also be needed to prevent parasitic leakage paths. The source and drain diffusions are partially separated by the field oxide, which provides an additional margin against adjacent diffusions punching through. Figs. 1, 2, 3, and 4 show the device cross-section after various processing steps.

P-well doping (Fig. 1) is accomplished by using ion implantation techniques. This results in well-controlled characteristics of the N-channel devices. Self-aligned polysilicon gates (Fig. 2) are used to minimize the gate-to-source or gate-to-drain overlap capacitance, thus enhancing the performance of the MOS transistors. The polysilicon is heavily doped in the field region and serves as a layer of conducting interconnect in addition to the metal.

The intermediate oxides in this process are deposited using the low-pressure chemical vapor deposition (LPCVD) technique, which provides improved oxide integrity and excellent step coverage. The resultant oxides are also more dense, which helps in contact-mask oxide etching because denser oxides have a lower and more controllable etch rate than other forms of deposited oxides. Different oxide thicknesses over the various contacts make the contact-mask etch a critical step that needs and receives close scrutiny.

The passivation layer to protect the circuit on the chip is plasma-deposited silicon nitride, which results in a protective barrier impervious to humidity and ionic contamination. This was needed to ensure the long-term reliability of the ICs in a hybrid or plastic package.

The well-being of the entire process is monitored by probing five test chips on each wafer. These test chips yield valuable information about device parameters such as device threshold voltage, junction breakdown voltage, and junction and parasitic leakage currents, along with data on gate oxide and metal step coverage integrity, and so on. The test chip usually provides the first hint of a process malfunction and in a normal mode gives statistical information on the process for trend-charting. It is also sometimes used for verifying circuit design concepts.

Preventing Latch-up

Latch-up via parasitic PNP transistors is a very common problem in all CMOS processes and special techniques

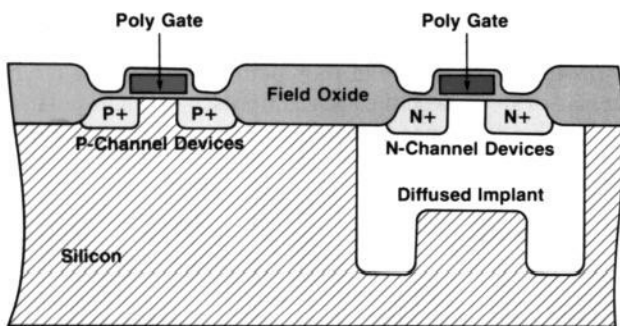

Fig. 3. After the P+ and N+ diffusions, more oxide is deposited over the P-channel and N-channel devices.

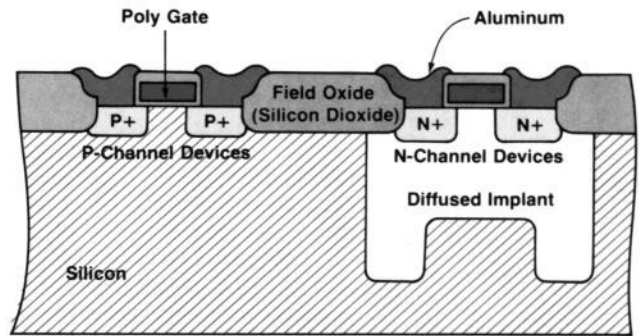

Fig. 4. Metal interconnection pattern is added to complete the CMOS structure. The final layer, the passivation layer, is not shown.

have to be implemented in both circuit design and processing to minimize its impact. Fig. 5 shows the cross-section and equivalent circuit of these four-layer devices.

Normally the PNP transistor (formed by the P+ diffusion, the N- substrate, and the P well) and the NPN transistor (formed by the N- substrate, the P well, and the N+ diffusion) are biased off. When abnormally high currents are present in either the P well or the substrate, the emitter junctions can be forward-biased, thereby turning on the parasitic PNP device.

Sensitivity to latch-up is reduced in two ways. The first is by increasing the spacing between the P+ and P-well junction to reduce the gain of the PNP transistors. The second is by ensuring that the P wells are adequately grounded.

Acknowledgments

The initial CMOS process development effort was started at ICL under the tutelage of John Moll and Juliana Manoliu. Thanks also go to Bob Grimm and Pat Castro for nurturing the effort for over two years and then doing the initial pilot production. At Corvallis Division Dave Rupprecht and his team were responsible for the initial setup of the process in production. Kuldeep Sethi and his team also contributed to the initial process characterization.

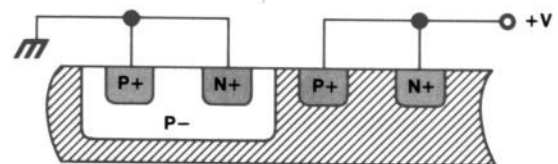

(a) CMOS cross-section

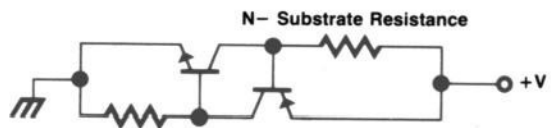

(b) Equivalent circuit of PNP parasitic device

Fig. 5. Cross-section and equivalent circuit of the parasitic PNP devices that cause latch-up.



Norman L. Johnson

Born in Sioux Falls, South Dakota, Norm Johnson received his BSEE and MSEE degrees from the South Dakota School of Mines and Technology in 1966 and 1967 respectively. His PhD degree in electrical engineering is from Oregon State University (1974). With HP since 1977, he worked on several of the HP-41C CMOS integrated circuits, including the CPU and display driver. Before coming to HP he was a process development engineer working on MNOS, N-channel SOS, and N-channel silicon gate integrated circuits. Married with two sons and living in Corvallis,

Norm and his family enjoy outdoor activities and camping in the beautiful Oregon countryside. He also does woodworking.

CORRECTION

Sharp eyed readers may have noticed in last month's issue that the drawing of the B450A optical system (Fig. 1, page 17) contained some linework errors that escaped even the authors' proofreading. The reference and sample beams actually reflect off all three of their respective cube corner mirrors instead of passing through the third one as shown. And the return beam from the reference cube corner mirrors actually goes under the fence window, not through it as shown.



Vijay V. Marathe

A native of Hyderabad, India, Vijay Marathe received his B.Tech degree in electrical engineering from the Indian Institute of Technology, Bombay, in 1964. He earned his MSEE degree from the University of California at Berkeley in 1966, and the following year came to HP. Since then he has worked in nearly all of HP's IC operations, including those at Santa Clara, Cupertino, the Desktop Computer Division and the integrated circuit laboratory of HP Laboratories. He was responsible for setting up the CMOS operation at the Corvallis Division and is now working in the components operation there. Vijay also holds an MBA degree, received in 1976 from Santa Clara University, and a DEE degree from the same university (1973). He is named inventor on two patents related to the HP-01 Calculator/Watch project. A member of the American Management Association and a first generation emigrant to the United States, Vijay has spent the past few years re-searching the various religions of the world, a subject he finds fascinating. He's an avid tennis and ping pong player and has been a stamp collector for 25 years. He and his wife and two children make their home in Corvallis, Oregon.

The First HP Liquid Crystal Display

by Craig Maze

LIQUID CRYSTAL DISPLAYS are used in calculators largely because of their inherent low power dissipation and low voltage requirements. Other factors contributing to their expanding use in calculators and portable instruments are the ease with which different character sizes and shapes can be produced inexpensively and LCDs' good visibility under conditions of high ambient lighting.

The display used in the HP-41C is a multiplexed, twisted nematic LCD with a twelve-character alphanumeric capacity. It operates from 0 to 45°C with electrical compensation of the drive voltage to correct for LC property variations with temperature.

LCDs are optically passive in that they do not generate light to produce contrast. Operation of the device depends on the ability of the LC to rotate plane polarized light relative to a pair of crossed polarizers attached to the outside of the display. Rotation of the plane of polarization is a function of the applied field and decreases with increasing field or voltage. The following brief discussion of LC properties and display construction will serve to explain how a

twisted nematic LCD works.

Nematic Liquid Crystal

Nematic liquid crystals are ordered fluids whose molecules lie parallel to each other with their centers of mass randomly distributed. They are organic compounds and their molecules are rod-like in overall shape. The word "nematic" comes from the Greek "nema", meaning "thread-like." A thread-like pattern is observed when nematics are viewed through a microscope under polarized light. The difference between nematic and ordinary fluids

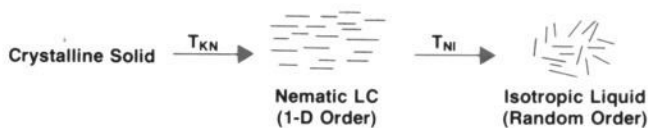

Fig. 1. Nematic liquid crystals are ordered fluids whose molecules lie parallel to each other. "Nematic" means "thread-like."

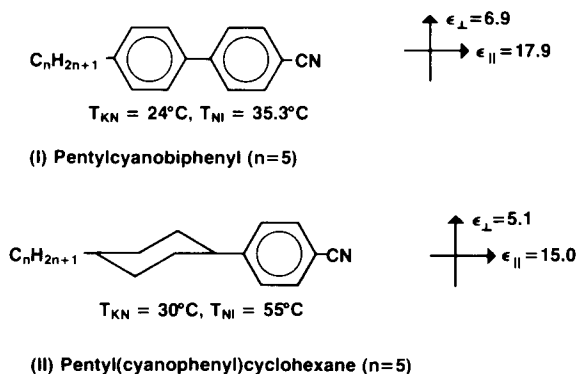

Fig. 2. Structures and properties of two commercially available nematic liquid crystal materials. The HP-41C display uses four compounds similar to type I.

is illustrated in Fig. 1.

Nematic liquid crystals are formed by melting otherwise ordinary crystalline solids. Unlike most solids, which transform into isotropic liquids upon melting, a nematic liquid crystal passes into an ordered phase at temperature T_{KN} . Additional heating, to T_{NI} , the clearing temperature, will cause the nematic to undergo another phase transformation where molecular order becomes random. To an observer, the solid will transform into a milky, light-scattering fluid at T_{KN} and then become clear at T_{NI} . Cooling reverses the sequence of transformations.

Nematic liquid crystals have one-dimensional, long-range order, are uniaxial crystals, behave like liquids, and possess elastic properties. Two examples of commercially available liquid crystals along with transition temperatures and dielectric properties are shown in Fig. 2.

The HP-41C uses a mixture of four liquid crystals similar to type I of Fig. 2. Multicomponent mixtures are necessary because no single compound has an appropriate nematic temperature range for use in products. In the case of the HP-41C, the nematic range is -10 to $60^\circ C$. Specified display operating temperature limits are always well within the nematic range. The ability of a display to perform at low temperature is usually limited by increasing viscosity and attendant slower on-off response, and not by freezing of the liquid. The upper bound results from highly nonlinear variations in LC properties with temperature, making compensation in the drive circuitry too complex.

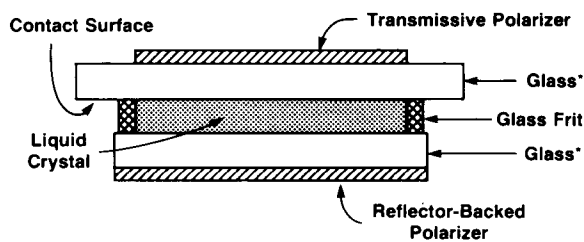

*Inside surfaces of glass coated with a patterned, transparent layer of indium and tin oxides.

Fig. 3. Construction of the HP-41C liquid crystal display.

To facilitate further discussion it is convenient to define a unit vector, called the director, which is parallel to the long molecular axis. LC structure and molecular orientation in a liquid crystal display can be discussed in terms of director orientation.

Dielectric anisotropy ($\epsilon_{\parallel} - \epsilon_{\perp}$) is positive for LC materials of types I and II and for mixtures used in twisted nematic displays. The largest component, ϵ_{\parallel} , is parallel to the director. Three elastic constants can be defined for nematic substances and used to describe the forces required to displace the director from its equilibrium position. These constants are many orders smaller than elastic moduli of ordinary solids. Even though small, a static balance between elastic and dielectric torques arises when a field is applied to an LCD. This balance produces a well-defined molecular structure that determines the degree to which the plane of polarization is rotated in a display.

Display Construction and Operation

Construction of the HP-41C display is depicted in Fig. 3, and Fig. 4 is the process flow sheet. The display is a parallel plate capacitor with polarizers bonded to the external surfaces. The two glass plates are separated by about ten micrometres and sealed with a vitreous glass frit. Liquid crystal fills the space between the plates, and the molecules are oriented with their directors in the plane of the substrate. The directors are also aligned parallel to the axis of the polarizer attached to the outside of the adjacent glass. A 90-degree director twist results with nematic order producing a uniform change across the liquid crystal layer. This structure is shown in Fig. 5a.

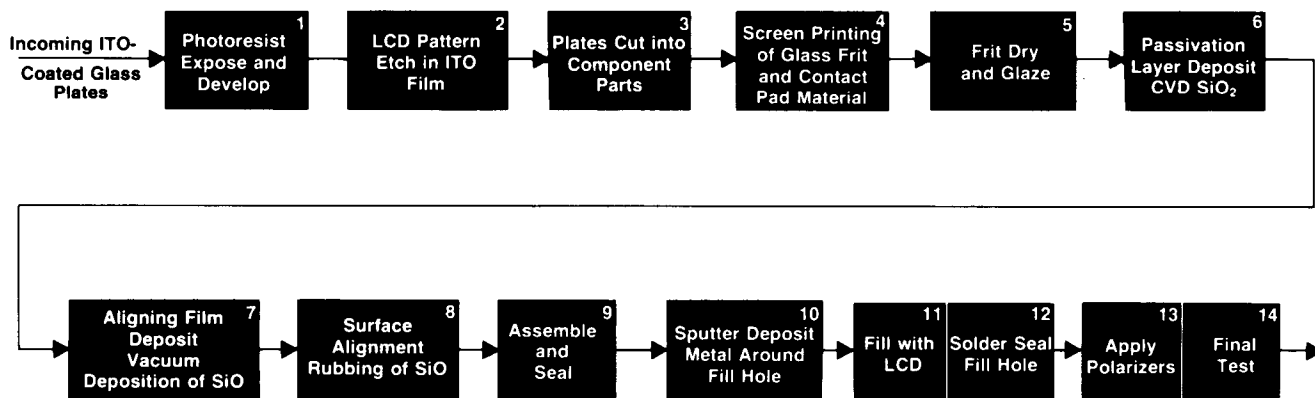
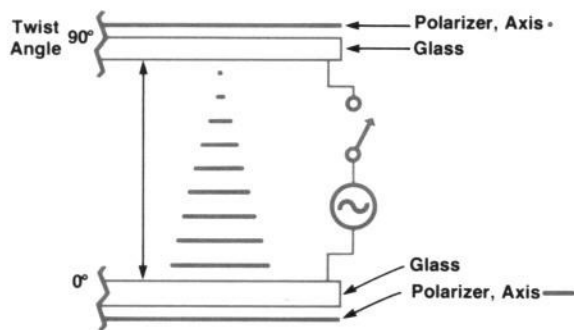

Fig. 4. HP-41C liquid crystal display manufacturing process.

Light passing through the first polarizer rotates 90 degrees as it passes through the LC layer. As a consequence it is aligned with the second polarizer, passes through, reflects, and propagates out unattenuated. The entire display appears light gray as a result of polarizer and reflector tints. Application of a voltage across the LC causes the directors to rotate so they are parallel to the applied field. At a sufficiently high voltage, alignment is nearly parallel as shown in Fig. 5b. The 90-degree director twist is eliminated, for all practical purposes, and light propagating through the LC is absorbed by the second polarizer. Dark digits appear in the active areas.

Director tilt increases with increasing voltage, and as a consequence, contrast develops first at lower voltages at shallow viewing angles. As shown in Fig. 6, brightness decreases at lower voltages at a 40-degree viewing angle compared to the curve representing zero-degree behavior.

Multiplexed displays operate with voltage applied at all times. To be off, nonselected elements must be above 90-percent brightness, and for the HP-41C, this is required to extend over a 40-degree angle. These two factors define the rms off voltage, as shown in Fig. 6. Good viewing also dictates that brightness be 50 percent or less for selected elements over the same 40-degree angle, and this voltage is also shown in Fig. 6.



(a) LCD off, molecules oriented by surface forces and twisted 90 degrees

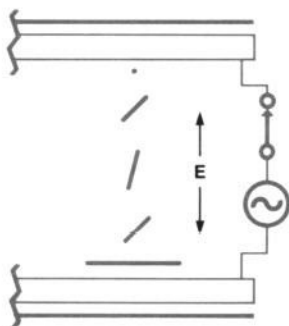

(b) LCD turned on, molecules tend to align with directors parallel to E-field.

Fig. 5. Liquid crystal display behavior in the on and off states. (a) When the display is off, the molecules are oriented by surface forces and twisted 90° from the top of the display to the bottom. The display appears light gray. (b) When a voltage is applied, the molecules tend to align parallel to the applied electric field. Light is absorbed by the bottom polarizer and the display turns dark in the active areas.

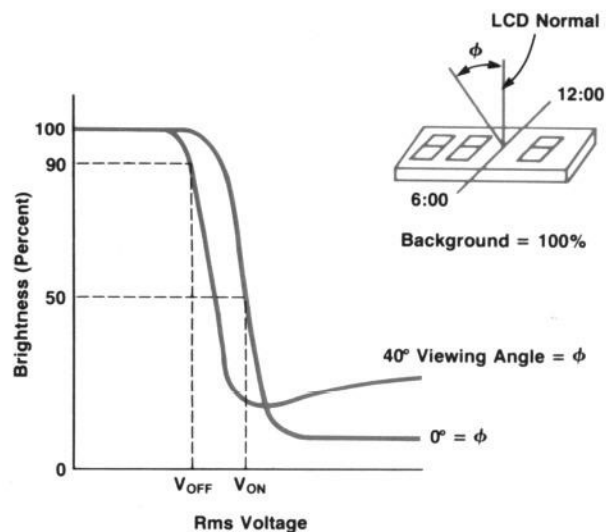

Fig. 6. Electro-optical response of a twisted-nematic LCD at two viewing angles.

A small V_{on}/V_{off} ratio is desirable for good optical performance for an LCD operating in the multiplexed mode. Proper selection of the LC material, care in LC surface alignment, and care in maintaining proper cell spacing all serve to maximize viewing angle and contrast for a given application.

Acknowledgments

Two separate groups have been involved in the development of LCD technology at HP. First, in Corvallis, thanks to Curt Sheley, Ed Heinsen, Paul Van Loan, Pat Shelley, and Earl Garthwait. At HP Labs credit goes to Fred Kahn, Hsia Choong, and Henry Birecki for their technical assistance over the past several years. Ed Kanazawa of Data Terminals Division and Sun Lu, formerly of HP, were also major contributors.

Craig Maze



A midwesterner from Galveston, Indiana, Craig Maze took his BS degree in chemical engineering from Purdue University in 1959, and later attended Iowa State University, where he earned his MS degree in 1967 and his PhD in 1970, both in chemical engineering. He joined HP in 1978 as a product engineer on the HP-41C liquid crystal display program. Author of 18 papers and named inventor on two patents, he worked in the fields of liquid crystals, polymer science, thermal analysis, surface chemistry, and computer modeling before joining HP. His professional memberships

include the American Chemical Society and the American Institute of Chemical Engineers. He has spent two years in the U.S. Army and taught thermodynamics and chemical instrumentation at Arizona State University. Now a resident of Corvallis, Oregon with his wife and three children, two of whom are in college, Craig spends his spare time gardening, trying his hand at photography, and generally enjoying outdoor activities.

High Density and Low Cost with Printed Circuit Hybrid Technology

by James H. Fleming and Robert N. Low

ONE OF THE MAJOR advantages of the HP-41C system is its compact size. To achieve high packaging density for each of the instruments of the system at a competitive price, a new hybrid packaging process needed to be developed. The IC package had to satisfy all of the individual product objectives and meet corporate reliability standards.

As an example of the need for the new process, the two 57-pin liquid crystal display driver chips mounted in standard dual in-line packages (DIPs) would occupy about 10 cm³, and the space available for the entire display assembly (including LCD and interconnects) was only one-sixth of this volume.

The cost, reliability, and performance (both electrical and environmental) of the new process had to be comparable to or better than a standard plastic DIP. This objective encompassed considerations of manufacturability on a high-volume production line, product flow and yields, testability and reworkability, materials cost and labor, as well as the package's ability to resist environmental stress conditions.

The Package

After thoroughly investigating existing technologies, the package configuration shown in Fig. 1 was chosen and implemented. The packaging scheme involves mounting the silicon chip directly onto a high-quality printed circuit board using a conductive epoxy. The IC is passivated in wafer form with a 7000Å film of silicon nitride. The chip's inputs and outputs are connected to the printed circuit board using 0.025-mm-diameter gold wires ultrasonically bonded at about 175°C. The IC and wires are encapsulated in epoxy to protect them from mechanical damage or gross condensation. The substrate is then connected to the outside world by a reflow solder operation. The resulting package satisfies all of the design objectives previously mentioned, and is fairly easily implemented, since it employs existing state-of-the-art technologies.

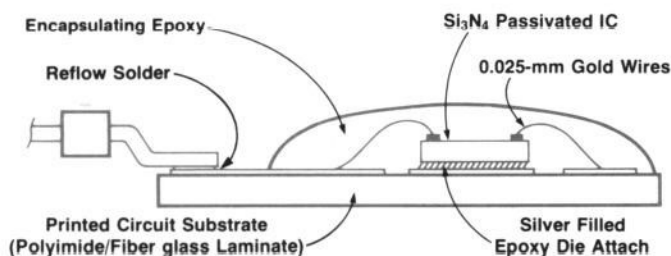

Fig. 1. General configuration of the hybrid packaging scheme used in most of the products in the HP-41C Calculator system.

Figs. 2, 3, and 4 are photos of the RAM, ROM, and display driver modules.

The Substrate

The CMOS ICs used in the HP-41C dissipate very little power, and are protected by a silicon nitride passivation layer, so heat dissipation and hermeticity (in the strictest sense) were not problems.

A polyimide/amide, fiberglass-laminate printed circuit board was chosen over a thin-film or thick-film ceramic substrate for reasons of cost, mechanical shock resistance, solderability, and machinability (allows for more diversity in shapes). Polyimide's temperature properties tolerate the high processing temperatures (greater than 175°C) better than standard epoxy/glass printed circuit boards.

State-of-the-art printed circuit board photolithography was required to resolve the 0.13-mm traces and 0.13-mm spaces. Along with the 0.33-mm (#80) plated-through holes, these give the greatest trace density now commercially available on two layers.

The ¼-ounce copper-clad laminate is plated with a

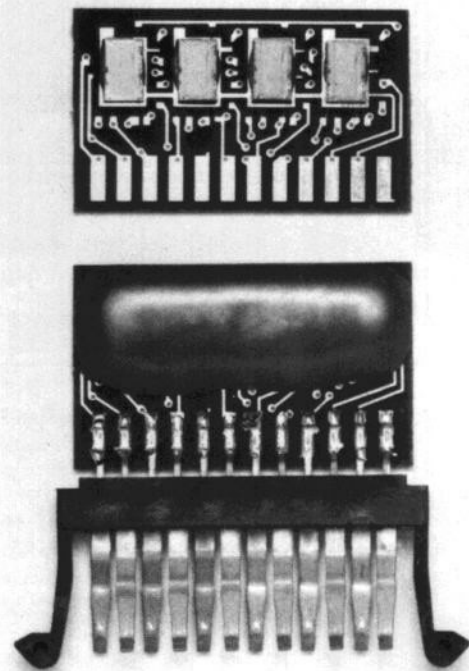

Fig. 2. RAM module contains four chips, each measuring 2.72 by 4.29 mm. Each chip contains sixteen 56-bit registers. There are 12-14 bonds per chip and ten connections via a reflow-soldered contact frame to the HP-41C. The substrate measures 23.37 x 13.72 x 0.79 mm.

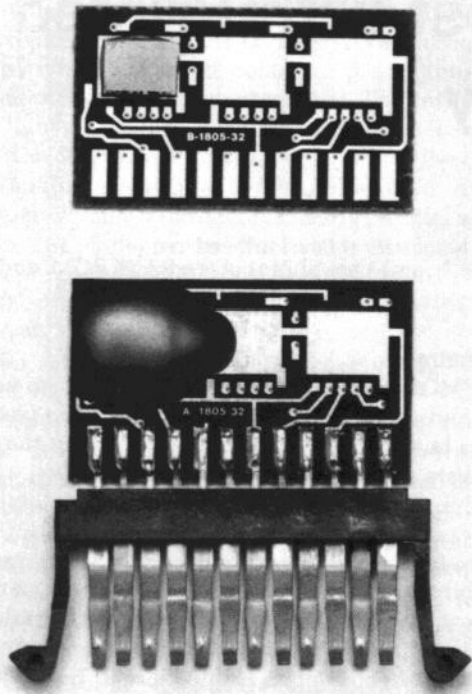

Fig. 3. ROM modules contain one or two chips, each measuring 3.71 by 5.00 mm and containing 40K bits. The bit pattern is customized for each application. There are 7-9 bonds per chip and ten connections via a reflow-soldered contact frame to the HP-41C. The substrate measures 23.37 x 13.72 x 0.79 mm.

0.005-mm nickel diffusion barrier and 0.0013 mm of gold to permit reliable bonding of the gold wires.

Acknowledgments

We would like to extend our sincere appreciation to all those who advised and supported our efforts, especially to Joe Lang, Don Keller, Jim Pollacek, and the entire IC assembly area, to Steve Hall, Sheshadri Iyengar and Norm Johnson for the product engineering support in components, to Bob Condor, Les Moore, Tom Pearo, and the rest of the tooling and electronic test group, to the QA department and Hope Keller, whose patience, organization and en-

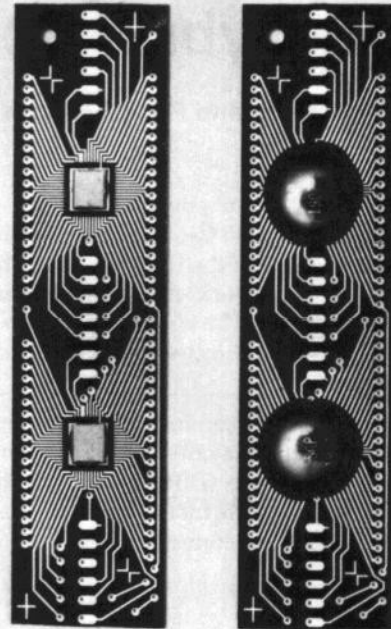

Fig. 4. Display driver module contains two chips, each measuring 4.17 by 3.63 mm. There are 54 bonds per chip, 14 connections to the HP-41C, and 72 connections to the liquid crystal display. Reflow-soldered contact tabs connect to the mainframe and flexible conductive strips connect to the LCD. The substrate measures 67.31 x 16.51 x 0.79 mm.

thusiasm made qualification possible, and to Thian Nie Khian, Lim Kok Chuan and the rest of the Singapore Division crew for their assistance during the production transfer.



Robert N. Low

Bob Low worked for Hewlett-Packard on the HP-01 during the summer of 1976 while a student at Purdue University, where he received his BS degree in metallurgical engineering in 1977. After graduation from Purdue he joined HP to work on the HP-41C system hybrid development, and then set up the HP-41C production line in Singapore. At present he is working on thin-film printhead evaluation and reliability improvement. Bob is a member of the American Ceramic Society. A native of South Bend, Indiana, he lives in Corvallis, Oregon. Skiing, hiking, carpentry, silversmithing, and sports cars keep his leisure hours busy.



James H. Fleming

Jim Fleming received a pair of BS degrees from Oregon State University, one in production technology (1961) and one in business administration (1962). With HP from 1963 to 1974, he left to form his own product design and manufacturing engineering consulting firm, then returned to HP a year and a half later. He's done product design, production engineering, materials engineering, and manufacturing engineering for several HP divisions and a variety of HP products, the latest being the HP-41C. His consulting work resulted in two patents on biological research equipment. Born in Oakland, California, Jim served in the U.S. Navy, and before joining HP, did mechanical design for a toymaking firm. He and his wife are both licensed pilots and enjoy touring the country in their Cessna 180. They have a son and live in Albany, Oregon. Jim spends his free time on house remodeling, his four-car classic auto collection, and his home-built airplane.